

SHARP®

LC-32LE700E LC-32LE700S
LC-40LE700E LC-40LE700S
LC-46LE700E LC-46LE700S
LC-52LE700E LC-52LE700S

LC-32LX700E LC-40LX700E LC-46LX700E
LC-32LU700E LC-32LU700S LC-40LU700E LC-40LU700S LC-46LU700E LC-46LU700S
LC-32LE705E LC-32LE705S LC-40LE705E LC-40LE705S
LC-46LE705E LC-46LE705S LC-52LE705E LC-52LE705S
LC-32LX705E LC-40LX705E LC-46LX705E
LC-32LU705E LC-32LU705S LC-40LU705E LC-40LU705S LC-46LU705E LC-46LU705S

LCD COLOUR TELEVISION
LCD-FARBFERNSEHGERÄT
TÉLÉVISEUR COULEUR À ÉCRAN
CRISTAUX LIQUIDES (LCD)
TELEVISORE A COLORI LCD
LCD-KLEURENTELEVISIE
TELEVISIÓN EN COLOR LCD
TELEVISOR DE CRISTAL LÍQUIDO

OPERATION MANUAL
BEDIENUNGSANLEITUNG
MODE D'EMPLOI
MANUALE DI ISTRUZIONI
GEbruIKSAANWIJZING
MANUAL DE MANEJO
MANUAL DE OPERAÇÃO

AQUOS



HD
TV
1080p

DOLBY
DIGITAL PLUS

HDMI™
HIGH-DEFINITION MULTIMEDIA INTERFACE

DVB
Digital Video
Broadcasting

ENGLISH

DEUTSCH

FRANÇAIS

ITALIANO



NEDERLANDS

ESPAÑOL

PORTUGUÊS



SPECIAL NOTE FOR USERS IN THE U.K.

The mains lead of this product is fitted with a non-rewireable (moulded) plug incorporating a 13A fuse. Should the fuse need to be replaced, a BSI or ASTA approved BS 1362 fuse marked  or  and of the same rating as above, which is also indicated on the pin face of the plug, must be used. Always refit the fuse cover after replacing the fuse. Never use the plug without the fuse cover fitted. In the unlikely event of the socket outlet in your home not being compatible with the plug supplied, cut off the mains plug and fit an appropriate type.

DANGER:

The fuse from the cut-off plug should be removed and the cut-off plug destroyed immediately and disposed of in a safe manner.

Under no circumstances should the cut-off plug be inserted elsewhere into a 13A socket outlet, as a serious electric shock may occur.

To fit an appropriate plug to the mains lead, follow the instructions below:

IMPORTANT:

The wires in the mains lead are coloured in accordance with the following code:

Blue: Neutral

Brown: Live

As the colours of the wires in the mains lead of this product may not correspond with the coloured markings identifying the terminals in your plug, proceed as follows:

- The wire which is coloured blue must be connected to the plug terminal which is marked N or coloured black.
 - The wire which is coloured brown must be connected to the plug terminal which is marked L or coloured red.
- Ensure that neither the brown nor the blue wire is connected to the earth terminal in your three-pin plug.

Before replacing the plug cover make sure that:

- If the new fitted plug contains a fuse, its value is the same as that removed from the cut-off plug.
- The cord grip is clamped over the sheath of the mains lead, and not simply over the lead wires.

IF YOU HAVE ANY DOUBT, CONSULT A QUALIFIED ELECTRICIAN.

- The illustrations and the OSD in this operation manual are for explanation purposes and may vary slightly from the actual operations.
- The examples used throughout this manual are based on the LC-46LE700E model.
- LC-32LE700E, LC-32LE700S, LC-32LX700E, LC-32LU700E, LC-32LU700S, LC-40LE700E, LC-40LE700S, LC-40LX700E, LC-40LU700E, LC-40LU700S, LC-46LE700E, LC-46LE700S, LC-46LX700E, LC-46LU700E, LC-46LU700S, LC-52LE700E, LC-52LE700S, LC-32LE705E, LC-32LE705S, LC-32LX705E, LC-32LU705E, LC-32LU705S, LC-40LE705E, LC-40LE705S, LC-40LX705E, LC-40LU705E, LC-40LU705S, LC-46LE705E, LC-46LE705S, LC-46LX705E, LC-46LU705E, LC-46LU705S, LC-52LE705E and LC-52LE705S models are compatible with H.264 (MPEG4 H.264, MPEG4 AVC, MPEG4 AVC/H.264) compressed broadcasts.
- Only the LC-32LE705E, LC-32LE705S, LC-40LE705E, LC-40LE705S, LC-46LE705E, LC-46LE705S, LC-32LX705E, LC-40LX705E, LC-46LX705E, LC-32LU705E, LC-32LU705S, LC-40LU705E, LC-40LU705S, LC-46LU705E and LC-46LU705S models are compatible with the Common Interface (CI) standard as well as the enhanced security Common Interface Plus (CI+) standard.

Dear SHARP customer

Thank you for your purchase of the SHARP LCD colour TV product. To ensure safety and many years of trouble-free operation of your product, please read **important safety precautions** carefully before using this product.

Trademarks

• "HDMI, the HDMI logo and High-Definition Multimedia Interface are trademarks or registered trademarks of HDMI Licensing LLC."

• Manufactured under license from Dolby Laboratories.
• "Dolby" and the double-D symbol are trademarks of Dolby Laboratories.

• The "HD TV 1080p" Logo is a trademark of EICTA.

• The DVB logo is the registered trademark of the Digital Video Broadcasting—DVB—project.

• LCフォント、LCFONT、エルシーフォント and LC logo mark are registered trademarks of SHARP Corporation. This product is embedded with LC Font technology, which was developed by SHARP Corporation for clearly displaying easy-to-read characters on an LCD screen. However, other non-LCD fonts are used for displaying some screen pages.

Introduction	2
Important safety precautions.....	2
Remote control unit	3
TV (front view)	4
TV (rear view)	4
Preparation	5
Supplied accessories	5
Attaching the stand unit	5
Inserting the batteries.....	6
Using the remote control unit	6
Quick guide	7
Initial installation overview.....	7
Before turning on the power	8
Initial auto installation	9
Inserting the CA card into the CI module.....	11
Watching TV	12
Daily operation	12
EPG.....	13
Teletext	15
Connecting external devices	16
Video connections	16
Audio connections.....	18
AQUOS LINK	19
Controlling HDMI devices using AQUOS LINK.....	19
AQUOS LINK connection.....	19
AQUOS LINK setup	20
Operating an AQUOS LINK device.....	21
Menu operation	22
What is the MENU?	22
Basic adjustment	23
Picture settings.....	23
Audio settings.....	25
Power save settings.....	26
Channel settings.....	27
Password/Parental lock settings	30
Other basic adjustments.....	30
Useful viewing functions	31
Selecting the picture size	31
Language settings	32
Display settings	33
Other useful features	34
Setting when using external devices	34
Additional features	34
Connecting a USB device	35
USB Photo viewer/Music player	35
Connecting a PC	37
Connecting a PC	37
Displaying a PC image on the screen.....	37
RS-232C port specifications	39
Appendix	41
Troubleshooting	41
Updating your TV via DVB-T	42
Reset	42
Identification	42
Updating your TV via USB	43
Specifications	44
Environmental specifications	46
End of life disposal.....	48

Introduction

Important safety precautions

- **Cleaning**—Unplug the AC cord from the AC outlet before cleaning the product. Use a damp cloth to clean the product. Do not use liquid cleaners or aerosol cleaners.
- Use a soft damp cloth to gently wipe the panel when it is dirty. To protect the panel, do not use a chemical cloth to clean it. Chemicals may cause damage or cracks in the cabinet of the TV.
- **Water and moisture**—Do not use the product near water, such as bathtub, washbasin, kitchen sink, laundry tub, swimming pool and in a wet basement.
- Do not place vases or any other water-filled containers on this product. The water may spill onto the product causing fire or electric shock.
- **Stand**—Do not place the product on an unstable cart, stand, tripod or table. Doing so can cause the product to fall, resulting in serious personal injuries as well as damage to the product. Use only a cart, stand, tripod, bracket or table recommended by the manufacturer or sold with the product. When mounting the product on a wall, be sure to follow the manufacturer's instructions. Use only the mounting hardware recommended by the manufacturer.
- When relocating the product placed on a cart, it must be moved with utmost care. Sudden stops, excessive force and uneven floor surface can cause the product to fall from the cart.
- **Ventilation**—The vents and other openings in the cabinet are designed for ventilation. Do not cover or block these vents and openings since insufficient ventilation can cause overheating and/or shorten the life of the product. Do not place the product on a bed, sofa, rug or other similar surface, since they can block ventilation openings. This product is not designed for built-in installation; do not place the product in an enclosed place such as a bookcase or rack, unless proper ventilation is provided or the manufacturer's instructions are followed.
- The LCD panel used in this product is made of glass. Therefore, it can break when the product is dropped or impact applied. If the LCD panel is broken, be careful not to be injured by broken glass.
- **Heat sources**—Keep the product away from heat sources such as radiators, heaters, stoves and other heat-generating products (including amplifiers).
- To prevent fire, never place any type of candle or naked flames on the top or near the TV set.
- To prevent fire or shock hazard, do not place the AC cord under the TV set or other heavy items.
- **Headphones**—Do not set the volume at a high level. Hearing experts advise against extended listening at high volume levels.
- Do not display a still picture for a long time, as this could cause an afterimage to remain.
- There is power consumption always if main plug is connected.
- **Servicing**—Do not attempt to service the product yourself. Removing covers can expose you to high voltage and other dangerous conditions. Request a qualified person to perform servicing.



The LCD panel is a very high technology product, giving you fine picture details.

Due to the very large number of pixels, occasionally a few non-active pixels may appear on the screen as a fixed point of blue, green or red. This is within product specifications and does not constitute a fault.

Precautions when transporting the TV

When transporting the TV, never carry it by holding onto the speakers. Be sure to always carry the TV by two people holding it with two hands—one hand on each side of the TV.

Devices connected to the protective earthing of the building installation through the MAINS connection or through other devices with a connection to protective earthing and to a television distribution system using coaxial cable, may in some circumstances create a fire hazard. Connection to a television distribution system therefore has to be provided through a device providing electrical isolation within a certain frequency range (galvanic isolator, see EN 60728-11).

NOTE

- For requirements in Norway and Sweden, the requirements for isolation are also relevant for devices that can be connected to television distribution systems.

Introduction

Remote control unit

- 1 **(Standby/On)**
(Page 12)
- 2 **Buttons for useful operations**
 - (Teletext)**
ATV: Display analogue teletext (Page 15).
DTV: Select MHEG-5 and teletext for DTV (Page 15).
 - (Hidden teletext)**
(Page 15)
 - (Subtitle)**
Switch subtitle languages on/off (Pages 15 and 32).
 - (Freeze/Hold)**
Press to freeze a moving image on the screen.
Teletext: Stop updating teletext pages automatically or release the hold mode.
 - (Subpage)**
(Page 15)
 - (Top/Bottom/Full)**
Set the area of magnification in teletext mode (Page 15).
- 3 **Numeric buttons 0–9**
Set the channel.
Enter desired numbers.
Set the page in teletext mode.
 - When the five Nordic countries (Sweden, Norway, Finland, Denmark or Iceland) are selected in the country setting from "Auto installation" (page 27), DTV services are four digits. When another country is selected, DTV services are three digits.
- 4 **(Flashback)**
Press to return to the previously selected channel or external input.
- 5 **DTV**
Press to access digital TV mode.
- 6 **ATV**
Press to access conventional analogue TV mode.
- 7 **(Sound mode)**
Select a sound multiplex mode (Page 12).
- 8 **(Volume)**
Increase/decrease TV volume.
- 9 **(Mute)**
TV sound on/off.

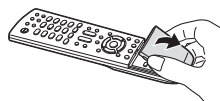
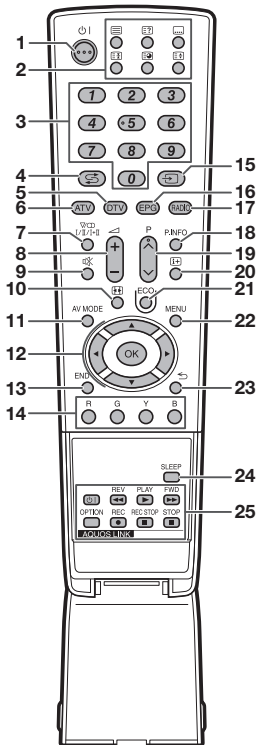

- 10 **(WIDE MODE)**
Select a wide mode (Pages 31 and 37).
 - 11 **AV MODE**
Select a video setting (Page 24).
 - 12 **(Cursor)**
Select a desired item on the setting screen.
- OK**
Execute a command within the "MENU" screen.
ATV/DTV: Display the programme list when no other "MENU" screen is running.

- 13 **END**
Exit the "MENU" screen.
- 14 **R/G/Y/B (Colour) buttons**
The coloured buttons are correspondingly used to select the coloured items on the screen (e.g., EPG, MHEG-5, teletext).
- 15 **(INPUT SOURCE)**
Select an input source (Page 12).
- 16 **EPG**
DTV: Display the EPG screen (Pages 13–14).
- 17 **RADIO**
DTV: Switch between radio and data mode.
 - When only data broadcasting (no radio broadcasting) is transmitted by DVB, the radio broadcasting will be skipped.
- 18 **P. INFO**
Press to display programme information which is transmitted through digital video broadcasting in the upper left corner of the screen (DTV only).
- 19 **(TV channel)**
Select the TV channel.
- 20 **(Display information)**
Press to display the station information (channel number, signal, etc.) in the upper right corner of the screen (Page 33).
- 21 **ECO (Standard/Advanced/Off)**
Select "Energy save" setting (Page 26).
- 22 **MENU**
"MENU" screen on/off.
- 23 **(Return)**
Return to the previous "MENU" screen.
- 24 **SLEEP**
Press to schedule a time for the TV to automatically standby (Page 26).
- 25 **AQUOS LINK buttons**
If external equipment such as a AQUOS BD player is connected via HDMI cables and is AQUOS LINK compatible, you can use these AQUOS LINK buttons. See pages 19 and 21 for details.

Introduction

TV (front view)

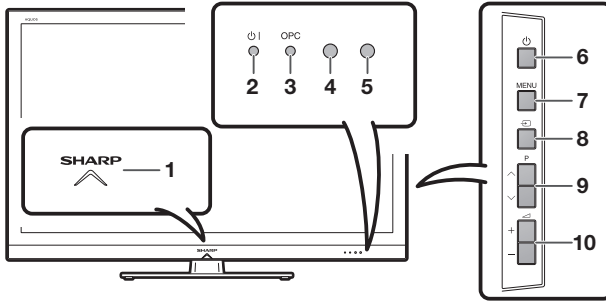

- 1 Blue illumination LED
- 2 (Standby/On indicator)
- 3 OPC indicator
- 4 Remote control sensor
- 5 OPC sensor
- 6 (Power button)
- 7 **MENU** (Menu button)
- 8 (Input source button)
- 9 **P**/**^**/**v** (Programme [channel] buttons)
- 10 (+/-) (Volume buttons)

TV (rear view)

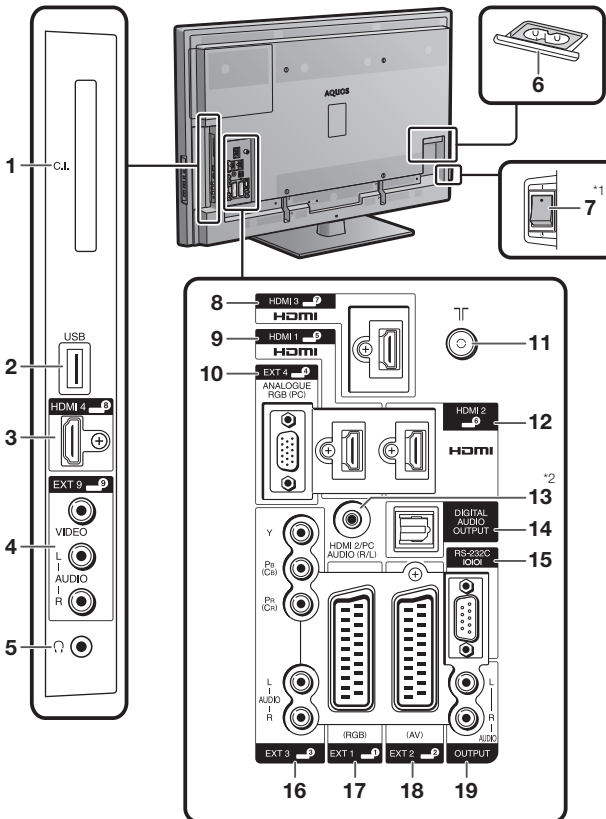

- 1 COMMON INTERFACE slot
- 2 USB terminal
- 3 HDMI 4 (HDMI) terminal
- 4 EXT 9 (VIDEO/AUDIO) terminals
- 5 Headphones
- 6 AC INPUT terminal
- 7 MAIN POWER switch
- 8 HDMI 3 (HDMI) terminal
- 9 HDMI 1 (HDMI) terminal
- 10 EXT 4 (ANALOGUE RGB (PC)) terminal
- 11 Antenna terminal
- 12 HDMI 2 (HDMI) terminal
- 13 HDMI 2/PC AUDIO (R/L) jack
- 14 DIGITAL AUDIO OUTPUT terminal
- 15 RS-232C terminal
- 16 EXT 3 (COMPONENT/AUDIO) terminals
- 17 EXT 1 (RGB) terminal
- 18 EXT 2 (AV) terminal
- 19 OUTPUT (AUDIO) terminals

WARNING

- Excessive sound pressure from earphones and headphones can cause hearing loss.
- Do not set the volume at a high level. Hearing experts advise against extended listening at high volume levels.

*1 When the MAIN POWER switch is turned off (D), the amount of electric power consumed will be reduced to 0.01 W or less. However, unlike when unplugging the AC cord, the power is not completely disconnected.

*2 The HDMI 2 and EXT 4 terminals can both use the same audio input terminal (HDMI 2/PC AUDIO (R/L)). However, the proper item must be selected in the "PC audio select" menu (refer to page 25 for details).

Preparation

Supplied accessories

Remote control unit (x 1)

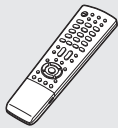

Pages 3 and 6

AC cord (x 1)

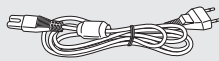

Product shape varies in some countries.

Page 8

Cable clamp (x 1)

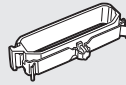

Page 8

Stand unit (x 1)



For 32 inch models



For 40/46/52 inch models



Page 5

- Operation manual (this publication)
- "AAA" size zinc-carbon battery (x 2) ... Page 6

Attaching the stand unit

- Before attaching (or detaching) the stand, unplug the AC cord from the AC INPUT terminal.
- Before performing work, spread cushioning over the surface on which you will be laying the TV. This will prevent it from being damaged.

CAUTION

- **Attach the stand in the correct direction.**
- **Be sure to follow the instructions. Incorrect installation of the stand may result in the TV falling over.**

- 1 Confirm that there are eight screws with the stand unit.

Models	Screws
32 inch models	
40/46/52 inch models	

- 2 Attach the supporting post for the stand unit onto the base using the four screws with the screw driver as shown.

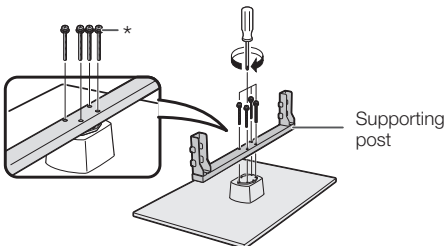

- * 32 inch models: Use **Screws B** in the table in step 1.
- * 40/46/52 inch models: Use **Screws D** in the table in step 1.

- 3 Inserting the stand.

- ① Insert the stand into the openings on the bottom of the TV (hold the stand so it will not drop from the edge of the base area).
- ② Insert and tighten the four screws into the four holes on the rear of the TV.

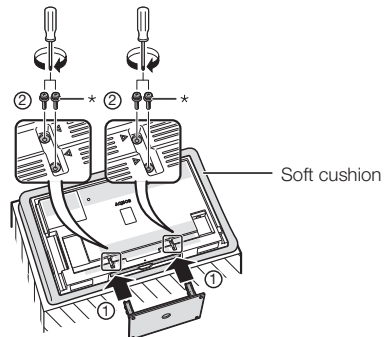

- * 32 inch models: Use **Screws A** in the table in step 1.
- * 40/46/52 inch models: Use **Screws C** in the table in step 1.

NOTE

- To detach the stand unit, perform the steps in reverse order.
- A screw driver is not supplied with this product.
- The stand base is made of glass. Therefore, be careful not to drop the stand base or apply pressure to it.
- Do not place heavy objects on the stand base.

Preparation

Inserting the batteries

Before using the TV for the first time, insert two supplied "AAA" size zinc-carbon batteries. When the batteries become depleted and the remote control unit fails to operate, replace the batteries with new "AAA" size batteries.

- 1 Open the battery cover.
- 2 Insert two supplied "AAA" size zinc-carbon batteries.
 - Place batteries with their terminals corresponding to the (+) and (-) indications in the battery compartment.
- 3 Close the battery cover.

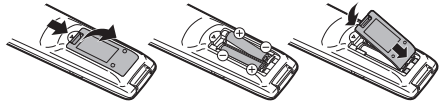

CAUTION

Improper use of batteries can result in chemical leakage or explosion. Be sure to follow the instructions below.

- Do not mix batteries of different types. Different types of batteries have different characteristics.
- Do not mix old and new batteries. Mixing old and new batteries can shorten the life of new batteries or cause chemical leakage in old batteries.
- Remove batteries as soon as they have worn out. Chemicals that leak from batteries can cause a rash. If you find any chemical leakage, wipe thoroughly with a cloth.
- The batteries supplied with this product may have a shorter life expectancy due to storage conditions.
- If you will not be using the remote control unit for an extended period of time, remove the batteries from it.
- When replacing the batteries, use zinc-carbon batteries instead of alkaline ones.

Note on disposing batteries

The batteries provided contain no harmful materials such as cadmium, lead or mercury.

Regulations concerning used batteries stipulate that batteries may no longer be thrown out with the household rubbish. Deposit any used batteries free of charge into the designated collection containers set up at commercial businesses.

Using the remote control unit

Use the remote control unit by pointing it towards the remote control sensor. Objects between the remote control unit and sensor may prevent proper operation.

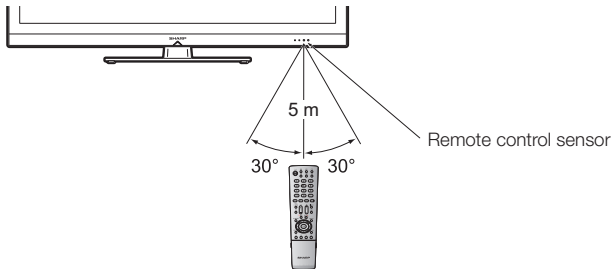

Cautions regarding the remote control unit

- Do not expose the remote control unit to shock. In addition, do not expose the remote control unit to liquids, and do not place in an area with high humidity.
- Do not install or place the remote control unit under direct sunlight. The heat may cause deformation of the unit.
- The remote control unit may not work properly if the remote control sensor of the TV is under direct sunlight or strong lighting. In such cases, change the angle of the lighting or the TV, or operate the remote control unit closer to the remote control sensor.

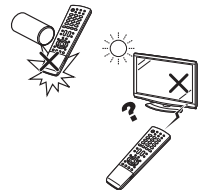

Quick guide

Initial installation overview

Follow the steps below one by one when using the TV for the first time. Some steps may not be necessary depending on your TV installation and connection.

1

Preparation

- 1 Connect an antenna cable to the antenna terminal (Page 8).

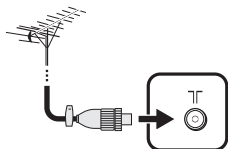

- 2 If necessary, insert a CA card into the CI slot to watch scrambled broadcasts (Page 11).



- 3 Connect the AC cord to the TV (Page 8).

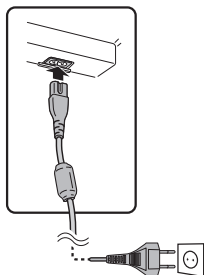

Product shape varies in some countries.

2

Run the initial settings

- 1 Turn on (I) the MAIN POWER switch on the left side of the TV (Page 4).

- The factory default for the MAIN POWER switch is set to on (I).

- 2 Turn on the power using (I) on the TV (Page 12).

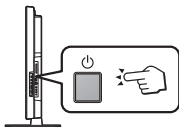

- 3 Run the initial auto installation (Page 9).

✓ Language setting



✓ Home/Store setting



✓ Country setting

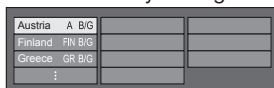

✓ Channel search setting



Start searching channels

3

Watch TV

- 1 **Congratulations!**
Now you can watch TV.

- 2 If necessary, adjust the antenna to attain maximum signal reception (Page 11).

Connect external devices

- 1 Connect external devices such as a DVD player/recorder as instructed (Pages 16–18).

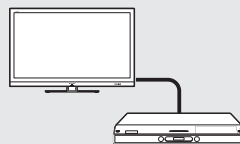

- 2 Connect external audio devices such as speakers/amplifier as instructed (Page 18).



Quick guide

Before turning on the power

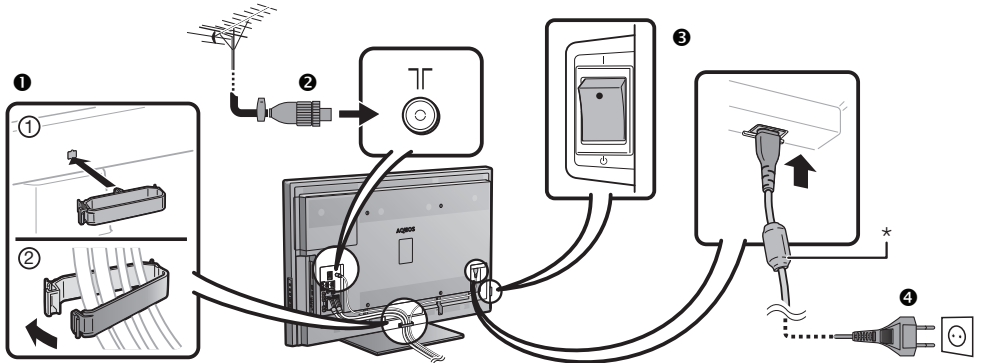

- 1 Cable clamp (bundle the cables with the clamp)
- 2 Standard DIN45325 plug (IEC 169-2) 75 Ω coaxial cable
- 3 Turn on (I) the MAIN POWER switch on the left side of the TV.
- 4 AC cord (product shape varies in some countries)

Place the TV close to the AC outlet, and keep the power plug within reach.

* The AC cord is supplied either with a ferrite core or without a ferrite core. Neither type causes unnecessary electrical wave emissions or interference.

Supplying power to the antenna

You must supply power to the antenna in order to receive digitally/terrestrially broadcast stations after connecting the antenna cable to the antenna terminal on the rear of the TV.

- 1 Press **MENU** and the "MENU" screen displays.
- 2 Press **◀/▶** to select "Setup".
- 3 Press **▲/▼** to select "Antenna setup-DIGITAL", and then press **OK**.
- 4 Press **▲/▼** to select "Supply voltage", and then press **OK**.
- 5 Press **◀/▶** to select "On", and then press **OK**.

Mounting the TV on a wall

- This TV should be mounted on a wall only with the wall mount bracket and attachment* available from SHARP (Page 46). The use of other wall mount brackets may result in an unstable installation and may cause serious injuries.
 - Mounting the LCD colour TV requires special skills and should only be performed by qualified service personnel. Customers should not attempt to do the work themselves. SHARP bears no responsibility for improper mounting or mounting that results in accident or injury.
 - You can ask qualified service personnel about using an optional bracket and attachment* to mount the TV to a wall.
 - When you mount the TV on a wall, you should attach the supporting post.
- * Only for 40 inch models.

Quick guide

Initial auto installation

When the TV is powered on for the first time after purchase, the initial auto installation wizard appears. Follow the menus and make the necessary settings one after another.

Confirm the following before turning on the power



- Is the antenna cable connected?
- Is the AC cord plugged in?
- Is the MAIN POWER switch turned on (I)?

1 Press on the TV.

- The initial auto installation wizard appears.



2 Setting the OSD language.



Press /// to select the desired language, and then press **OK**.

3 Selecting the location of the TV.



Press / to select where you will use this TV, and then press **OK**.

- HOME: "STANDARD" will be the default value for the "AV MODE" setting.
- STORE: "DYNAMIC (Fixed)" will be the default value for the "AV MODE" setting. If the "AV MODE" is changed, the TV will automatically switch back to "DYNAMIC (Fixed)" when there is no signal input from the TV or remote control unit for 30 minutes.
- A demonstration image will be displayed after initial auto installation is completed. If you have chosen "STORE" by mistake, go to "Setup" > "Reset" > select "HOME" again.

4 Setting the country.



Press /// to select your country or area, and then press **OK**.

- This setting screen only appears during the first installation.

NOTE

- If you set "Sweden" in the country setting, you can select the cable provider "ComHem". Refer to the **ComHem** mark in the following steps or instructions about the settings for "ComHem".

5 Starting channel search.

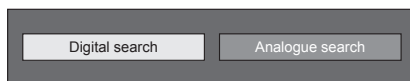



Press / to select "Digital search" or "Analogue search", and then press **OK**.

- To watch both analogue broadcasts and digital broadcasts, you should perform the auto installation setting for each format (Page 27).
- If you want to search for more broadcasts, execute "Additional search" from the "Programme setup" menu (Pages 27–29).

NOTE

- If you turn off the power on the TV while performing a channel search, the initial auto installation wizard will not appear. The auto installation function allows you to execute the installation again from the "Setup" menu (Page 27).
- The initial auto installation wizard will abort if you leave the TV unattended for 30 minutes before searching for channels.
- After initial auto installation is completed, the default PIN is automatically set to "1234". To change the PIN setting, refer to **Password/Parental lock settings** (Page 30). To clear the PIN setting (PIN input will no longer be needed), refer to **CLEARING THE PIN** (Page 41).
- When "Italy" is selected in the country setting, the default age restriction value is set to 18.

Digital broadcast setting

Press / to select "Terrestrial" or "Cable", and then press **OK**.



ComHem

- When you set "Sweden" in the country setting and select "Cable" for the searching format, you can select the cable provider "ComHem".

Searching for terrestrial broadcasts

The TV searches for, sorts and stores all the receivable TV stations according to their settings and the connected antenna.

- To abort the initial auto installation in progress, press .

Quick guide

Searching for cable broadcasts

To change each item to the appropriate settings:

- Press ▲/▼ to select the menu, and then press **OK**.

Scrambled stations	[Yes]
Search method	[Channel]
Start frequency	[47.0]
Network ID	[None]
Symbol rate 1	[6875]
Symbol rate 2	[6900]
QAM modulation 1	[64]
QAM modulation 2	[256]
Reset	
Search start	

- Press ▲/▼/◀/▶ or 0-9 to select or input the appropriate item/value, and then press **OK**.
 - Press ▲/▼ to select "Search start", and then press **OK**.
 - The TV searches for, sorts and stores all the receivable TV stations according to their settings and the connected antenna.
- To abort the initial auto installation in progress, press ⏏.

ComHem

- The "Scrambled stations" menu and the "Search method" menu are not displayed on the screen as each menu item is fixed.
- The value of "Start frequency" and "Network ID" should be set to the value specified by the cable provider.

Menu	Description	Selectable items
Scrambled stations	Specifies if you need to add pay-TV services.	Yes, No
Search method	Specifies how you search channels.	Channel: Extracts all of information from a channel (quick, but needs corresponding TV stations). Frequency: Checks every frequency in range (slow).
Start frequency		From 47.0-858.0 MHz
Network ID	Specifies the network. Set this to register only the specified network ID without registering any special services.	None, 0-65535
Symbol rate 1*	The symbol rates are specified by the cable provider. Input the value received for CATV.	1000-9000
Symbol rate 2*	The symbol rates are specified by the cable provider. Input the value received for CATV.	1000-9000
QAM modulation 1		16, 32, 64, 128, 256
QAM modulation 2		None, 16, 32, 64, 128, 256

* Set up "Symbol rate 2" if the cable provider uses several symbol rates.

ComHem

- When you set "Sweden" in the country setting and select "Cable" for the searching format, you can select the cable provider "ComHem". Follow the screen prompts.

Analogue broadcast setting

The TV searches for, sorts and stores all the receivable TV stations according to their settings and the connected antenna.

- To abort the initial auto installation in progress, press ⏏.

Quick guide

Checking signal strength and channel strength (DVB-T/C)

If you install a DVB-T/C antenna for the first time or relocate it, you should adjust the alignment of the antenna to receive a good reception while checking the antenna setup screen.

Go to "MENU" > "Setup" > "Antenna setup-DIGITAL".

Checking signal strength

Press ▲/▼ to select "Signal strength", and then press **OK**.

Supply voltage	
Signal strength	
Channel strength	CH no. 21
	Signal strength
	Current 0 Max. 0
	Quality
	Current 0 Max. 0

Checking channel strength

Press ▲/▼ to select "Channel strength", and then press **OK**.

- You can input a specified frequency band using the 0-9 numeric buttons.

Channel strength of DVB-T

Supply voltage	
Signal strength	4 7 4 . 0 MHz
Channel strength	CH no. 21
	Signal strength
	Current 0 Max. 0
	Quality
	Current 0 Max. 0

Channel strength of DVB-C

Supply voltage	
Signal strength	Frequency 4 7 4 . 0 MHz
Channel strength	Symbol rate * * * *
	QAM modulation 64
	Signal strength
	Current 0 Max. 0
	Quality
	Current 0 Max. 0

- Position and align the antenna so that the maximum possible values for "Signal strength" and "Quality" are obtained.

NOTE

- The values of "Signal strength" and "Quality" indicate when to check the appropriate alignment of the antenna.

Inserting the CA card into the CI module

In order to receive coded digital stations, a common interface module (CI module) and a CA card must be inserted in the CI slot of the TV.

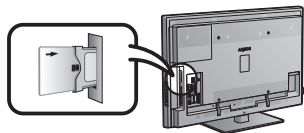

- Carefully insert the CI module in the CI slot with the contact side forward.
- The logo on the CI module must be facing outward from the rear of the TV.

NOTE

- Only the LC-32LE705E, LC-32LE705S, LC-40LE705E, LC-40LE705S, LC-46LE705E, LC-46LE705S, LC-32LX705E, LC-40LX705E, LC-46LX705E, LC-32LU705E, LC-32LU705S, LC-40LU705E, LC-40LU705S, LC-46LU705E and LC-46LU705S models are compatible with the Common Interface (CI) standard as well as the enhanced security Common Interface Plus (CI+) standard.
- It takes about 30 seconds to certify the license key when you insert a CA card into the CI+ compatible CI module for the first time. This process may fail when there is no antenna input or you have never run "Auto installation".
- The CI+ compatible CI module sometimes upgrades its firmware. You may not receive any TV images before upgrading. You can only use the power button during upgrading.
- The CI+ compatible CI module does not allow you to output any copy protected programmes using monitor out. In this case, the copy protect icon* is shown in the programme information when **P. INFO** is pressed.
- Protect icon:
- If the TV displays an update confirmation message for the CA card while receiving CI+ compatible broadcasts, follow the screen prompts.
- Make sure that the CI module is properly inserted.

Checking CI module information

Go to "MENU" > "Digital setup" > "CI menu".

- This menu is only available for digital stations.
- The content of this menu depends on the provider of the CI module.

Module

General information on CI module displays.

Menu

Adjustment parameters of each CA card displays.

Enquiry

You can input numerical values such as passwords here.

Watching TV

Daily operation

Switching on/off

Turning on/off the power

- 1 Turn on (I) the MAIN POWER switch on the left side of the TV (Page 4).
- 2 Press on the TV.
Switch it off by pressing on the TV.
 - When turning off the power using on the TV, EPG data will be lost.

Standby mode

To standby mode

If the TV is switched on, you can switch it to standby by pressing on the remote control unit.

Switching on from standby

From standby, press on the remote control unit.



TV indicator status

(Standby/On indicator)	Status
Off	Power off
Green	Power on
Red	Standby

NOTE

- If you are not going to use this TV for a long period of time, be sure to remove the AC cord from the AC outlet or turn off () the MAIN POWER switch on the left side of the TV (Page 4).
- A small amount of electric power is still consumed even when is turned off.

Switching between digital and analogue broadcasts

Watching digital broadcasts

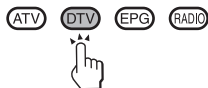

Watching analogue broadcasts



Changing channels

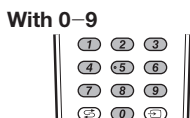

Selecting an external video source

Once the connection is made, press to display the "INPUT SOURCE" screen, and then press or to switch over to the appropriate external source with **OK**.

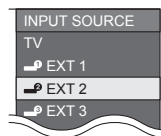

Selecting a sound mode

DTV mode

If multi sound modes are received, each time you press the mode switches as follows.

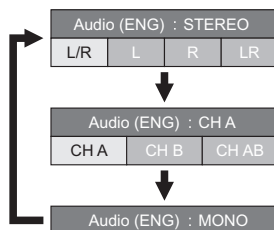

Press to select L or R sound when the STEREO or DUAL MONO screen is displayed.



NOTE

- The sound mode screen disappears in six seconds.
- Selectable items vary depending on the received broadcasts.

ATV mode

Each time you press , the mode switches as shown in the following tables.

NICAM TV broadcasts selection	
Signal	Selectable items
Stereo	NICAM STEREO, MONO
Bilingual	NICAM CH A, NICAM CH B, NICAM CH AB, MONO
Monaural	NICAM MONO, MONO
A2 TV broadcasts selection	
Signal	Selectable items
Stereo	STEREO, MONO
Bilingual	CH A, CH B, CH AB
Monaural	MONO

NOTE

- When no signal is input, the sound mode will display "MONO".

Watching TV

EPG

EPG is a programme list that is displayed on the screen. With the EPG, you can check the schedule of DTV/RADIO/DATA, view detailed information about them, tune to an event currently on-air.

Useful settings for using EPG

Basic operation

- 1 Press **MENU** and the "MENU" screen displays.
- 2 Press **◀/▶** to select "Digital setup".
- 3 Press **▲/▼** to select "EPG setup", and then press **OK**.

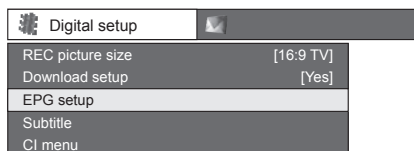

- 4 Press **▲/▼** to select the desired item, and then press **OK** (e.g., "EPG setup", "Display range setup", etc.).

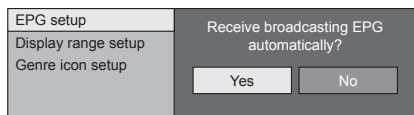

- 5 Press **▲/▼/◀/▶** to select or adjust the desired item, and then press **OK** (e.g., "Yes", "No", etc.).

EPG display settings

● EPG setup (setting for receiving EPG data)

If you want to use the EPG for digital stations, select "Yes". The EPG data must be automatically captured while the TV is in standby mode. After setting to "Yes", it may take some time to turn off the power using the remote control unit due to the process of the data capture.

NOTE

- If the MAIN POWER switch or the power button on the TV are switched off, the EPG data will not be captured.

● Display range setup

The "Display range setup" allows you to select three types of time spans for display on the screen.

Item	
Mode 1 (Wide angle)	Displays six hours of programme information.
Mode 2 (Zoom)	Displays three hours of programme information.
Mode 3 (Vertical angle)	Changes to the EPG display format with a vertical time span.

● Genre icon setup

You can grey out or place a mark on desired genres and smoothly search for programmes you frequently watch.

● Genre icon list

Icon	Genre	Icon	Genre
	Movie/Drama		Music/Ballet/Dance
	News/Current affairs		Arts/Culture (without music)
	Show/Game show		Social/Political issues/Economics
	Sports		Education/Science/Factual topics
	Children's/Youth programmes		Leisure hobbies

Selecting a programme using EPG

Basic operation

The illustrations on this page are explained using three digit services.

● Display/Close the EPG screen

Press **EPG**.

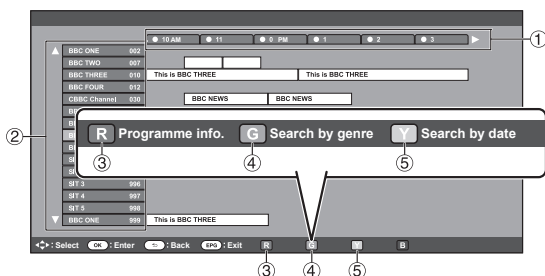
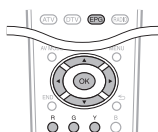

● Select a programme

① Select the time span

Press **◀/▶** to select the time span you want to search.

- Continue to press **▶** to display programmes in the next time span.

② Select the desired programme

Press **▲/▼** to select the desired programme.

- If **▲** or **▼** are displayed on the left of the services, continue to press **▲/▼** to display next or previous screen.

Useful functions

③ Check programme information

- 1 Press **▲/▼/◀/▶** to select the programme you want to check.
- 2 Press **R**, and then press **OK** to tune to the selected programme.

④ Search a programme in a category

- 1 Press **G**.
- 2 Press **▲/▼** to select the desired genre, and then press **OK**.
- 3 Press **▲/▼** to select a programme you want to watch, and then press **OK**.
 - Refer to page 13 for the genre setting.

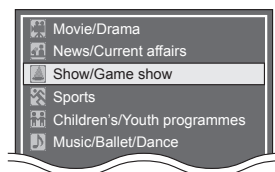

⑤ Search for a programme by date/time

- 1 Press **Y**.
- 2 Press **◀/▶** to select the desired time span, and then press **OK**.

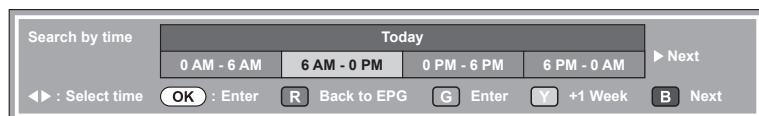

- 3 Press **▲/▼** to select the desired programme, and then press **OK**.

Watching TV

Teletext



What is teletext?

Teletext broadcasts pages of information and entertainment to specially equipped TV. Your TV receives teletext signals broadcast by a TV network, and decodes them into graphical format for viewing. News, weather and sports information, stock exchange prices and programme previews are among the many services available.

Turning teletext on/off

- 1 Select a TV channel or external source providing a teletext programme.
- 2 Press  to display the teletext.
 - Many stations use the TOP operating system, while some use FLOF (e.g., CNN). Your TV supports both these systems. The pages are divided into topic groups and topics. After switching on the teletext, up to 2,000 pages are stored for fast access.
 - If you select a programme with no teletext signal, "No Teletext available" displays.
 - The same message displays during other modes if no teletext signal is available.









- Each time you press , the screen switches as shown above.
- Press  again to display the teletext on the right screen and the normal image on the left screen.

NOTE

- Teletext will not work if the selected signal type is RGB (Page 34).

Buttons for teletext operations

Buttons	Description
	Increase or decrease the page number.
Colour (R/G/Y/B)	Select a group or block of pages displayed in the coloured brackets at the bottom of the screen by pressing the corresponding colour (R/G/Y/B) on the remote control unit.
Numeric buttons 0–9	Directly select any page from 100 to 899 by using the 0–9 numeric buttons.
 (Top/Bottom/Full)	Switch the teletext image to top, bottom or full.
 (Reveal hidden teletext)	Reveal or hide hidden information such as an answer to a quiz.
 (Freeze/Hold)	Stop updating teletext pages automatically or release the hold mode.
 (Subtitle for teletext)	Display the subtitle or exit the subtitle screen. <ul style="list-style-type: none">• Subtitles will not be displayed when the service does not contain subtitle information.
 (Subpage)	Reveal or hide subpages. <ul style="list-style-type: none">• Move to the previous subpage (R).• Move to the following subpage (G).• These two buttons are shown on the screen by the symbols "+" and "-".

Using the MHEG-5 application (UK only)

Some services bring you programmes with the MHEG application encoded, letting you experience DTV interactively. When provided, the MHEG-5 application will start when you press .

Connecting external devices

Before connecting ...

- Be sure to turn off the TV and any devices before making any connections.
- Firmly connect a cable to a terminal or terminals.
- Carefully read the operation manual of each external device for possible connection types. This also helps you get the best possible audiovisual quality to maximise the potential of the TV and the connected device.
- Refer to page 37 for connecting a PC to the TV.

NOTE

- The cables illustrated in pages 16–18 are commercially available items.

Video connections

HDMI connection

Example of connectable devices

- DVD player/recorder
- Blu-ray player/recorder
- Game console

The HDMI connections permit digital video and audio transmission via a connection cable from a player/recorder. The digital picture and sound data are transmitted without data compression and therefore lose none of their quality. Analogue/digital conversion is no longer necessary in the connected devices, which also would result in quality losses.

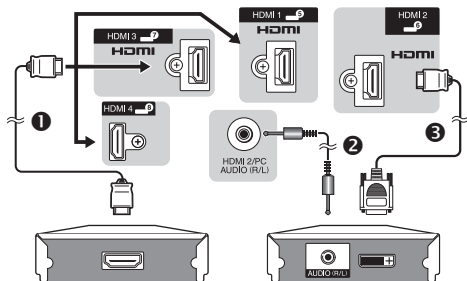

- 1 HDMI-certified cable
- 2 \varnothing 3.5 mm stereo minijack cable
- 3 DVI/HDMI cable

DVI/HDMI conversion

Using a DVI/HDMI cable, the digital video signals of a DVD can also be played via the compatible HDMI connection. The sound must be fed in additionally.

- When connecting a DVI/HDMI cable to the HDMI terminal, the image may not come in clearly.
- Both HDMI and DVI use the same HDCP copy protection method.

When using the HDMI 2 terminal

You must set the audio signal input source depending on the type of HDMI cable connected (refer to page 25 for details).

HDMI-certified cable

Go to "MENU" > "Option" > "PC audio select" > select "EXT 4 (RGB)".

DVI/HDMI cable

Go to "MENU" > "Option" > "PC audio select" > select "HDMI 2".

NOTE

- If a connected HDMI device is AQUOS LINK compatible, you can take advantage of versatile functions (Pages 19–21).
- Video noise may occur depending on the type of HDMI cable used. Make sure to use a certified HDMI cable.
- When playing the HDMI image, the best possible format for the picture will be detected and set automatically.

Supported video signal

576i, 576p, 480i, 480p, 1080i, 720p, 1080p
See page 38 for PC signal compatibility.

Connecting external devices

SCART connection

Example of connectable devices

- Decoder

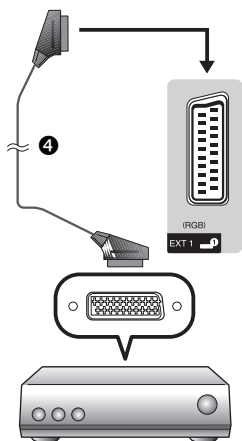

Decoder

4 SCART cable

Example of connectable devices

- VCR
- DVD player/recorder

If your VCR supports TV-VCR advanced AV Link systems, you can connect the VCR using a fully wired SCART cable.

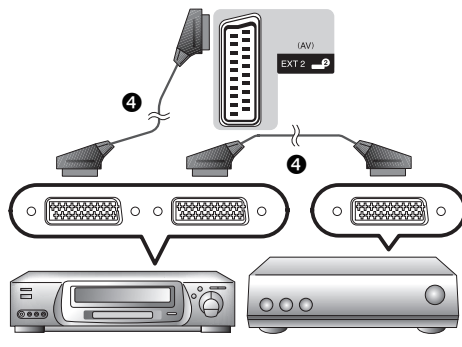

VCR

Decoder

4 SCART cable

NOTE

- In cases when the decoder needs to receive a signal from the TV, make sure to select the appropriate input terminal to which the decoder is connected in "Manual adjust" in the "Analogue setting" menu (Page 29).
- TV-VCR advanced AV Link systems may not be compatible with some external sources.
- You cannot connect the VCR with decoder using a fully wired SCART cable when selecting "Y/C" under "EXT 2" in the "Input select" menu.

Controlling devices with SCART using AV Link

This TV incorporates four typical AV Link functions for smooth connections between the TV and other audiovisual equipment.

One touch play	While the TV is in standby mode, it automatically turns on and plays back the image from the audiovisual source (e.g., VCR, DVD player/recorder).
TV standby	When the TV enters standby mode, the connected audiovisual equipment (e.g., VCR, DVD player/recorder) enters standby mode as well.
WYSIWYR	When the remote control unit of the connected VCR has the WYSIWYR button, you can automatically start recording by pressing the WYSIWYR button.
Preset download	Automatically transfers the channel preset information from the tuner on the TV to the one on the connected audiovisual equipment (e.g., VCR) via the EXT 2 terminal.

NOTE

- Refer to the operation manuals of external equipment for details.
- The AV Link function works only when audiovisual equipment is connected to the EXT 2 terminal with a fully wired SCART cable.
- The use of the AV Link function is only possible if the TV has enforced a complete auto installation with the connected audiovisual equipment (refer to **Initial auto installation** on page 9).

The availability of the AV Link function depends on the audiovisual equipment used. Depending on the manufacturer and type of equipment used, it is possible that the described functions may be completely or partially unusable.

- When the TV receives a scrambled DTV signal, the WYSIWYR function may not work.
- If the TV's received signal is switched to a scrambled signal during recording with the WYSIWYR function, black images will be recorded in the external device.

Connecting external devices

Component connection

- Example of connectable devices**
- VCR
 - DVD player/recorder

You will enjoy accurate colour reproduction and high quality images through the EXT 3 terminal when connecting a DVD player/recorder or other device.

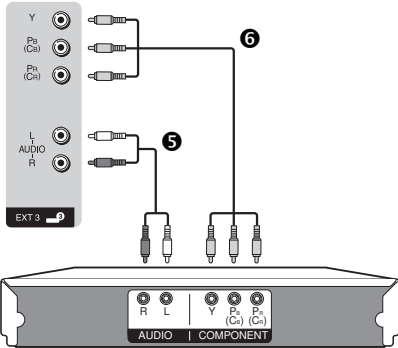

- 5 Audio cable
- 6 Component cable

VIDEO connection

- Example of connectable devices**
- VCR
 - DVD player/recorder
 - Game console
 - Camcorder

You can use the EXT 9 terminal when connecting to a game console, camcorder, a DVD player/recorder or other device.

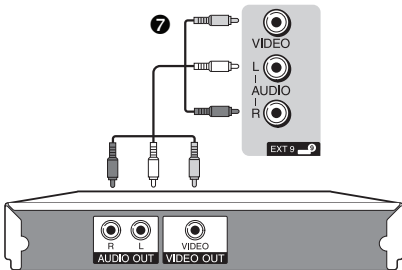

- 7 AV cable

Audio connections

Speaker/amplifier connection

Connect an amplifier with external speakers as shown below.

- **Connecting an amplifier with digital/analogue audio inputs**

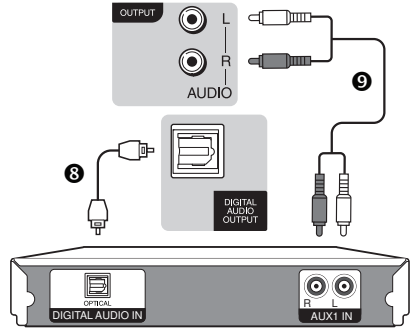

- 8 Optical audio cable (for digital audio input)
- 9 Audio cable (for analogue audio input)

After connecting

Digital audio output setting

After connecting an amplifier with digital audio input and external speakers as shown, you should set an audio output format compatible with the programme you are watching or the device connected.

Go to "MENU" > "Option" > "Digital audio output" > select "PCM" or "Dolby Digital".

NOTE

- When set to "Dolby Digital", Dolby Digital is output when the Dolby Digital or Dolby Digital Plus audio formats are received. When set to "PCM", PCM is output no matter what audio formats are received.

AQUOS LINK

Controlling HDMI devices using AQUOS LINK

● What is AQUOS LINK?

Using the HDMI CEC protocol, with AQUOS LINK you can interactively operate compatible system devices (AV amplifier, DVD player/recorder, Blu-ray player/recorder) using a single remote control unit.

NOTE

- AQUOS LINK-compatible AQUOS AUDIO speaker system and AQUOS recorder are scheduled to be on sale after the release of this TV.

● What you can do with AQUOS LINK

✓ One touch recording (DTV only)

You do not have to search for the remote control unit of your recording device. Press the **REC** ● or **REC STOP** ■ buttons inside the flip cover to start/stop recording what you see on the recorder.

✓ One touch play

When the TV is in standby mode, it will automatically turn on and play back the image from the HDMI source.

✓ Single remote control operation

AQUOS LINK automatically recognises connected HDMI devices and you can control the TV and the devices as if using a universal remote control unit.

✓ Operating title list of external devices

In addition to displaying the TV's own timer list (Page 14), you can also call up the external player's top menu or AQUOS BD player's/AQUOS recorder's title list provided that the devices support AQUOS LINK.

✓ Multiple control of HDMI devices

You can select which HDMI device to operate using the **OPTION** button.

NOTE

- When you use AQUOS LINK, make sure to use a certified HDMI cable.
- Point the remote control unit toward the TV, not to the connected HDMI device.
- Video noise may occur depending on the type of HDMI cable used. Make sure to use a certified HDMI cable.
- Up to three HDMI recording devices, one AV amplifier and two players can be connected using this system.
- These operations affect the HDMI device selected as the current external source. If the device does not operate, turn on the device and select the appropriate external source using **→**.
- When you insert/remove HDMI cables or change connections, turn on all connected HDMI devices before turning on the TV. Confirm that picture and audio are correctly output by selecting "HDMI 1", "HDMI 2", "HDMI 3" or "HDMI 4" from the "INPUT SOURCE" menu.

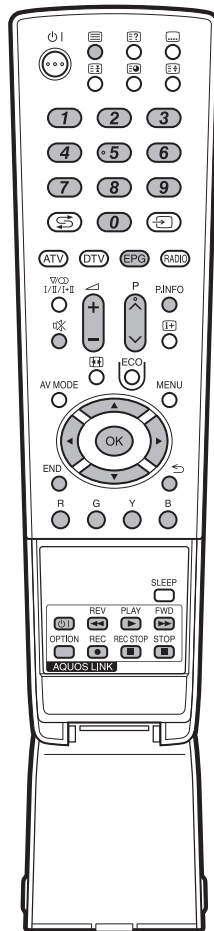

AQUOS LINK connection

First connect the AQUOS AUDIO speaker system or an AQUOS BD player/AQUOS recorder that supports the HDMI CEC protocol.

NOTE

- Refer to the operation manual of the device to be connected for further details.
- After unplugging connection cables or changing the connection pattern, turn on the power of the TV after all relevant devices' power have been turned on. Change the external input source by pressing **→**, select the appropriate external source and verify the audiovisual output.
- The cables illustrated in the following explanation are commercially available items.

AQUOS LINK

Connecting an AQUOS BD player/AQUOS recorder via the AQUOS AUDIO speaker system

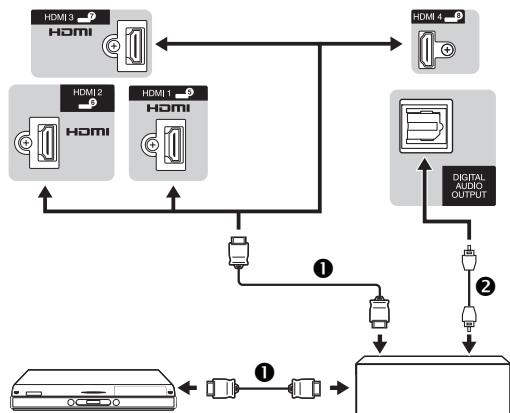

AQUOS BD player/AQUOS recorder

AQUOS AUDIO speaker system

① HDMI-certified cable

② Optical audio cable

Connecting an AQUOS BD player/AQUOS recorder only

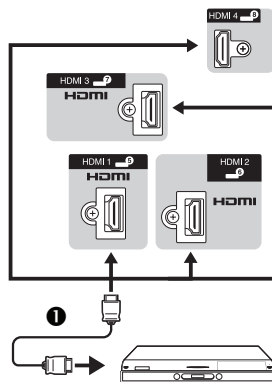

AQUOS BD player/AQUOS recorder

AQUOS LINK setup

Basic operation

Go to "MENU" > "Option" > "AQUOS LINK setup" > select the menu you want to set.

AQUOS LINK control

Set to "On" to enable HDMI CEC functions.

Auto power on

If this is activated, the one touch play function is enabled. While the TV is in standby mode, it automatically turns on and plays back the image from the HDMI source.

NOTE

- The factory default for this item is "Off".

Selecting recorder

Here, you can select a recorder for the recording from several connected recorders.

NOTE

- If you have connected the AQUOS AUDIO speaker system between the TV and an AQUOS recorder, the external source's indication changes (e.g., from "HDMI 1" to "HDMI 1 (Sub)").

Selecting channel key

This function allows you to select the channel of the connected HDMI device using the TV's remote control unit.

- 1 Press **▲/▼** to select the input source of the connected HDMI device you want to control using the TV's remote control unit, and then press **OK**.
- 2 Press **◀/▶** to select "On", and then press **OK**.

Using genre info

This function allows you to automatically switch to the appropriate sound mode depending on the genre information included in the digital broadcast.

Operating an AQUOS LINK device

AQUOS LINK allows you to operate the HDMI-connected device with a single remote control unit.

- 1 Open the remote control unit's flip cover.
- 2 Press **PLAY** ► to start playback of a title.
 - See the right column, section **Top menu/Title list** if you want to start playback using the list of the titles of the AQUOS BD player/AQUOS recorder.
- 3 Press **FWD** ►► to fast forward.
Press **REV** ◀◀ to reverse.
Press **STOP** ■ to stop.
Press **⏻** | to turn the HDMI-connected device on/off.

AQUOS LINK menu

"AQUOS LINK menu" allows you to arrange the settings for the sound or external devices, etc.

● Displaying "AQUOS LINK menu"

Open the remote control unit's flip cover, and then press **OPTION**.

By AQUOS AUDIO SP

You can choose to listen to the TV sound only from the AQUOS AUDIO speaker system.

Press ▲/▼ to select "By AQUOS AUDIO SP", and then press **OK**.

- The sound from the TV speaker and headphone terminal is silenced and only the sound from the AQUOS AUDIO speaker system is audible.

By AQUOS SP

You can choose to listen to the TV sound only from the AQUOS TV speaker system.

Press ▲/▼ to select "By AQUOS SP", and then press **OK**.

Sound mode change

You can manually change the AQUOS AUDIO speaker system's sound mode.

- 1 Press ▲/▼ to select "Sound mode change".
- 2 The sound mode changes every time you press **OK**.
 - Refer to the operation manual of the AQUOS AUDIO speaker system for details.

Setup menu

You can call up the menu of an HDMI CEC-compatible external device (player, recorder, decoder, etc.) using the "Setup menu" function.

Press ▲/▼ to select "Setup menu", and then press **OK**.

NOTE

- If a connected device does not have this function or the device is in a status where the menu cannot be displayed (recording, entering standby, etc.), this function may not be available.

Top menu/Title list

This section explains how to play back a title in the AQUOS BD player/AQUOS recorder.

- 1 Press ▲/▼ to select "Top menu/Title list", and then press **OK**.
 - The linked recorder now powers on and the TV automatically selects the appropriate external input source.
 - The title list data from the connected AQUOS BD player/AQUOS recorder displays.
- 2 Select the title with ▲/▼/◀/►, and then press **PLAY** ►.

Media change

If your recorder has multiple storage media, select the media type here.

- 1 Press ▲/▼ to select "Media change", and then press **OK**.
- 2 Select the desired medium, such as DVD recorder or HDD. The media type changes every time you press **OK**.

Model select

If multiple HDMI devices are connected in a daisy chain, you can specify which device to control here.

Press ▲/▼ to select "Model select", and then press **OK**. The HDMI device changes every time you press **OK**.

Recorder EPG

You can call up the CEC-compatible recorder's EPG and preset timer recordings using the TV's remote control unit.

- 1 Press ▲/▼ to select "Recorder EPG", and then press **OK**.
 - The external input source switches and the recorder's EPG is displayed.
- 2 Select the programme to record.
 - Refer to the operation manual of the recorder for details.

Menu operation

What is the MENU?

- You need to call up the OSD to perform settings for the TV. The OSD for the settings is called "MENU".
- The "MENU" enables various settings and adjustments.

Basic operation

1

Display the MENU screen

Press **MENU** and the "MENU" screen displays.

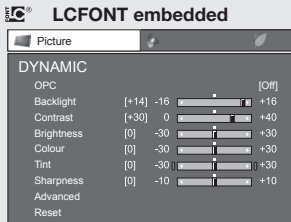

2

Select an item

Press **▲/▼/◀/▶** to select/adjust the desired menu, and adjust the item to the desired level, and then press **OK**. Press **↶** to return to the previous "MENU" page.

Selecting in the MENU

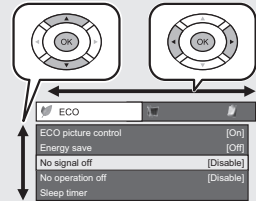

Selecting options

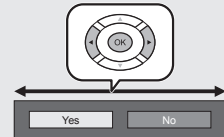

3

Exit the MENU screen

The operation will exit the "MENU" screen if you press **END** before it is completed.

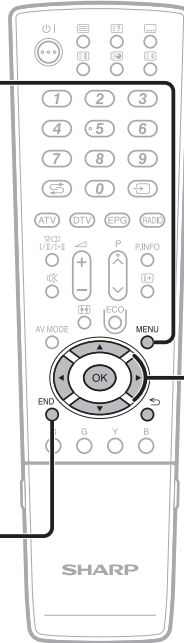

LCFONT

This product is embedded with LC Font technology, which was developed by SHARP Corporation for clearly displaying easy-to-read characters on LCD screens.

NOTE

- "MENU" options differ in the selected input modes, but the operating procedures are the same.
- Items with cannot be selected for various reasons.
- The "MENU" screen will disappear if left unattended for several seconds.

Operation without a remote control unit

This function is useful when there is no remote control unit within your reach.

- 1 Press **MENU** and the "MENU" screen displays.
- 2 Press **P▲/▼** instead of **▲/▼** or **▶/←** instead of **◀/▶** to select the item.
- 3 Press **↶** to complete the setting.



About the guide display

The guide display at the bottom of the screen shows operations with the OSD.

- The bar above is an operational guide for the remote control unit. The bar will change in accordance with each menu setting screen.

Select **OK** Enter Back **MENU** End

Basic adjustment

Picture settings

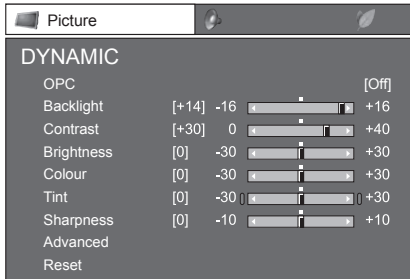

Picture OPC

Automatically adjusts the brightness of the screen.

Item	
Off	The brightness is fixed at the value set in "Backlight".
On	Automatically adjusts.
On:Display	Displays the OPC effect on the screen while adjusting the brightness of the screen.

NOTE

- When set to "On", the TV senses the surrounding light and automatically adjusts the backlight brightness. Make sure no object obstructs the OPC sensor, which could affect its ability to sense surrounding light.

Picture Picture adjustments

Adjusts the picture to your preference with the following picture settings.

Adjustment items

Selectable items	◀ (Cursor)	▶ (Cursor)
Backlight	The screen dims	The screen brightens
Contrast	For less contrast	For more contrast
Brightness	For less brightness	For more brightness
Colour	For less colour intensity	For more colour intensity
Tint	Skin tones become purplish	Skin tones become greenish
Sharpness	For less sharpness	For more sharpness

Picture Advanced

This TV provides various advanced functions for optimising the picture quality.

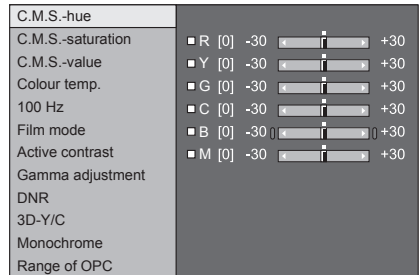

C.M.S.-hue

This function adjusts the hue of a selected colour using a six-colour adjustment system.

C.M.S.-saturation

This function increases or decreases the saturation of a selected colour using a six-colour adjustment system.

C.M.S.-value

This function adjusts the brightness of a selected colour using a six-colour adjustment system.

Colour temp.

Adjusts the colour temperature to give the best white image.

Item	
High	White with bluish tone.
Mid-High	Intermediate tone between "High" and "Middle".
Middle	Natural tone.
Mid-Low	Intermediate tone between "Middle" and "Low".
Low	White with reddish tone.
R/G/B Gain (LO), R/G/B Gain (HI)	Adjusts the white balance by changing the value of each item.

Basic adjustment

100 Hz

"100 Hz" technology provides superior solutions for digital display picture quality removing motion blur.

NOTE

- This effect is greater on fast moving images.
- "100 Hz" will have no effect in the following cases.
 - 1) The type of signal received is a PC signal.
 - 2) An OSD is being displayed.
 - 3) Teletext is activated.
- If images appear blurred, set the "100 Hz" to "Off".

Film mode

Automatically detects a film-based source (originally encoded at 24 or 25 frames per second, depending on the vertical frequency), analyses it and then recreates each still film frame for high-definition picture quality ("Advanced (High)", "Advanced (Low)", "Standard", "Off").

Active contrast

Automatically adjusts the contrast of an image according to the scene.

Gamma adjustment

Selects the tone difference of the brightness and darkness of the image according to the type of programme watched from a maximum of + 2 to a minimum of - 2.

DNR

"DNR" produces a clearer image ("Off", "High", "Middle", "Low", "Auto").

NOTE

- This function may not be available depending on the input signal type.

3D-Y/C

Provides high quality images with minimal dot crawl and cross colour noise by detecting changes in the image.

Item	
Standard	Normal adjustment.
Fast	Sets the optimum image quality for fast-moving images.
Slow	Sets the optimum image quality for slow-moving images.

NOTE

- "3D-Y/C" may not operate depending on the input signal type or when the input signal is noisy.
- "3D-Y/C" has even more effect on composite video signals (CVBS).

Monochrome

For viewing a video in black & white.

Range of OPC

The brightness level range of the OPC sensor's automatic adjustments can be set according to your preferences. The adjustment range of the OPC sensor can be set to a maximum of + 16 and a minimum of - 16.

NOTE

- This function is available only when the "OPC" setting is set to "On" or "On:Display".
- The maximum setting cannot be set to a smaller number than the minimum setting.
- The minimum setting cannot be set to a bigger number than the maximum setting.
- The maximum and minimum settings cannot be set to the same number.
- Depending on the brightness of the surrounding light, the OPC sensor might not operate if the adjustment range is small.

AV MODE

"AV MODE" gives you several viewing options to choose from to best match the system environment, which can vary due to factors like room-brightness, type of programme watched or the type of image input from external equipment.

- 1 Press **AV MODE**.
- 2 Each time you press **AV MODE**, the mode changes.
 - You can also switch the mode on the "Picture" and "Audio" menu screen by pressing **AV MODE**.

Item	
STANDARD	For a highly defined image in a normally bright room.
MOVIE	For viewing a movie in a darkened room.
GAME	For playing of video games.
PC*	For PC.
USER	Allows you to customise settings as desired. You can set the mode for each input source.
DYNAMIC (Fixed)	For a clear-cut image emphasising high contrast for sports viewing (the "Picture" and "Audio" settings cannot be adjusted).
DYNAMIC	For a clear-cut image emphasising high contrast for sports viewing.
AUTO	The TV automatically sets the appropriate selection from the "AV MODE" menu depending on the lighting conditions and the type of programme watched.

NOTE

- The item marked with * is available only when selecting "HDMI 1", "HDMI 2", "HDMI 3", "HDMI 4" or "EXT 4" from the "INPUT SOURCE" menu.
- If you select "AUTO", some selections in the "AV MODE" menu may not be automatically set.

Basic adjustment

Audio settings

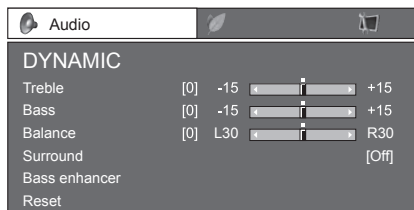

Audio Audio adjustment

You can adjust the sound quality to your preference with the following settings.

Selectable items	◀ (Cursor)	▶ (Cursor)
Treble	For weaker treble	For stronger treble
Bass	For weaker bass	For stronger bass
Balance	Decrease audio from the right speaker	Decrease audio from the left speaker

Audio Surround

This function allows you to enjoy realistic live sound.

Audio Bass enhancer

This function allows you to enjoy bass-enhanced sound.

Automatic volume adjustment

Option Auto volume

Different sound sources sometimes do not have the same volume level, such as a programme and its commercial breaks. This function reduces this problem by equalizing levels.

Emphasising dialogue

Option Clear voice

This function emphasises speech against background noise for greater clarity.

Outputting audio only

Option Audio only

When listening to music from a music programme, you can set the TV off and enjoy audio only.

	Item
Off	Both screen images and audio are output.
On	Audio is output without a screen image.

Setting audio input

Option PC audio select

When using the EXT 4 terminal or HDMI 2 terminal, you must select which terminal uses the AUDIO (R/L) jack for analogue audio input.

	Item
HDMI 2	When connecting devices (including a PC) with DVI/HDMI cable to the HDMI 2 terminal and inputting analogue audio signals from the AUDIO (R/L) jack.
EXT 4 (RGB)	When connecting a PC to the EXT 4 terminal, and inputting analogue audio signals from the AUDIO (R/L) jack.

NOTE

- You must set this to "EXT 4 (RGB)" when connecting devices (including a PC) with an HDMI-certified cable to the HDMI 2 terminal. If "HDMI 2" is set, there will be no sound output.

Basic adjustment

Power save settings

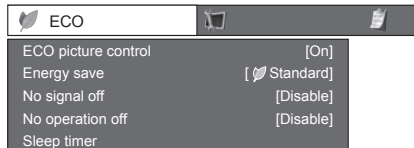

ECO ECO picture control

This function automatically detects the image source and decreases the power consumption while keeping the brightness of the image unchanged.

NOTE

- This function does not work when "AV MODE" is set to "DYNAMIC (Fixed)" or "AUTO".
- This function does not work when "Energy save" is set to "Standard" or "Advanced".

ECO Energy save

This function enables you to reduce the backlight brightness in order to decrease the power consumption and increase the backlight life span as shown in the following table.

Item	
Standard	Reduces the backlight brightness.
Advanced	Reduces the backlight brightness more than "Standard".
Off	The backlight brightness is the same value of your settings in the selected "AV MODE".

NOTE

- This function does not work when "AV MODE" is set to "DYNAMIC (Fixed)".

“Energy save” status icons

Icon	Description
	"Energy save" is set to "Standard".
	"Energy save" is set to "Advanced".

When "Energy save" is set to "Standard" or "Advanced", "Energy save" status icons appear in the "Picture" menu and channel information windows as shown in the following examples.

EXAMPLE



- When "OPC" is set to "On" or "On:Display", an "Energy save" status icon appears to the left of "OPC" in the "Picture" menu.
- When "OPC" is set to "Off", an "Energy save" status icon appears to the left of "Backlight" in the "Picture" menu.

EXAMPLE

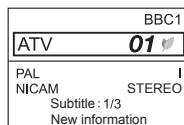

ECO No signal off

When set to "Enable", the TV will automatically enter standby mode if there is no signal input for 15 minutes.

NOTE

- Even if a TV programme finishes, this function may not operate because of interference from other TV stations or other signals.

ECO No operation off

The TV will automatically enter standby mode if no operations are performed during the time span you set ("30 min." or "3 hr.").

NOTE

- Five minutes before the TV enters standby mode, the remaining time displays every minute.

ECO Sleep timer

Allows you to set a time when the TV automatically enters standby mode.

NOTE

- Select "Off" to cancel the sleep timer.
- When the time has been set, countdown automatically starts.
- Five minutes before the preset of time expires, the remaining time displays each minute.

Basic adjustment

Channel settings

Auto installation



Setup

Auto installation

The TV automatically detects and stores all available services in your area. This function also allows you to perform the channel setting for digital and analogue individually and reconfigure the settings after the initial auto installation has been completed.

- 1 Press **◀/▶** to select “Yes”, and then press **OK**.
- 2 Press **▲/▼/◀/▶** to select the desired language, and then press **OK**.

NOTE

- PIN input is required when executing “Auto installation”. The default PIN is “1234”. To change the PIN setting, refer to **Password/Parental lock settings** (Page 30). To clear the PIN setting (PIN input will no longer be needed), refer to **CLEARING THE PIN** (Page 41).
- You cannot set the Home/Store setting and the country setting in “Auto installation” in the “Setup” menu. If you want to reconfigure those settings, automatically execute initial auto installation after executing “Reset” from the “Setup” menu.
- The current country setting is displayed on the screen.

- 3 Press **▲/▼** to select the broadcast standard you want to search, and then press **OK**.

Digital search

After selecting the service you want to search, either “Terrestrial” or “Cable”, refer to **Digital broadcast setting** on pages 9–10.

- The “Digital search” has a “Reset” function. This function allows you to reset all setting values.

Analogue search

The TV searches for, sorts and stores all the receivable TV stations. Refer to **Analogue broadcast setting** on page 10.

Programme setup



Setup

Programme setup

You can reconfigure the DTV service settings automatically or manually.

Press **▲/▼** to select the broadcast standard you want to reconfigure, and then press **OK**.

NOTE

- PIN input is required when executing “Programme setup”. The default PIN is “1234”. To change the PIN setting, refer to **Password/Parental lock settings** (Page 30). To clear the PIN setting (PIN input will no longer be needed), refer to **CLEARING THE PIN** (Page 41).

Digital setting

Additional search

Use this menu to add new services automatically after “Digital search” in the “Auto installation” menu has been completed.

Manual search

Add new services within a specified frequency band.

- Enter the frequency using **0–9** numeric buttons.
- You can perform “Manual search” with a service number only when the five Nordic countries have been selected in the country setting.

Basic adjustment

Manual adjust

Configure various settings for each service using the colour (R/G/B) buttons.

Service no.	Service name	Lock	CH skip	Old LCN
DTV 993	SIT 3			
DTV 994	SIT 2	✓		
DTV 995	SIT 1		✓	

DTV 999	HD Monosco			
---------	------------	--	--	--

R: Lock **G**: CH skip **B**: Sort

- 1 Press ▲/▼ to select the desired service.
- 2 Press the colour button on the remote control unit corresponding with the item you want to reconfigure.
 - The ✓ mark indicates the operation is set to on. Each time the colour button is pressed, you can switch the corresponding operation on/off.

Buttons for “Manual adjust” operation

Lock	Press R button.
-------------	-----------------

When the service is locked, you must enter your PIN whenever you tune to the service.

CH skip	Press G button.
----------------	-----------------

Services with a ✓ mark are passed over when pressing P▲/▼ on the TV or remote control unit.

Sort	Press B button.
-------------	-----------------

The item position of services can be sorted.

- ① Press ▲/▼ to select the service whose item position you want to move, and then press **OK**.

DTV 994	SIT 2	✓
DTV 995	SIT 1	✓

- ② Press ▲/▼ to move it to the desired position, and then press **OK**.

DTV 994	SIT 1	✓
DTV 995	SIT 2	✓

- ③ Repeat steps 1 and 2 until all desired service items are sorted.

Cable setting

Additional search

Use this menu to add new services automatically after “Digital search” in the “Auto installation” menu has been completed. Follow steps ① to ④ in **Searching for cable broadcasts** on page 10.

Manual search

Add new services within a specified frequency band. After setting the items on the following screen, the TV starts searching.

- Refer to the table about menu items in the right column on page 10.

Frequency	[47.0]
QAM modulation	[64]
Symbol rate	[6900]
Search start	

47.0 MHz

Manual adjust

This function is the same as in “Digital setting”. Refer to “Manual adjust” in “Digital setting”.

ComHem

- You can only reconfigure the “Manual adjust” settings.
- You can only set the “Lock” setting in “Manual adjust”.

Basic adjustment

Analogue setting

You can reconfigure the analogue TV channels settings automatically or manually.

Additional search

Use this menu to add new services automatically after "Analogue search" in the "Auto installation" menu has been completed.

- Start searching channels after selecting the colour system and sound system.

Manual adjust

Use this menu to set up analogue TV channels manually.

After selecting "Yes" on the screen, press **▲/▼/◀/▶** to select the channel you want to set and then press **OK**.

Fine

You can adjust the frequency to the desired position.

NOTE

- Adjust while checking the background picture as a reference.
- Instead of pressing **◀/▶** to adjust the frequency, you can set by directly entering the frequency number of the channel with **0-9** numeric buttons.

EXAMPLE

- 179.25 MHz: Press 1 > 7 > 9 > 2 > 5.
- 49.25 MHz: Press 4 > 9 > 2 > 5 > **OK**.

Colour sys.

Select the optimum colour system to receive ("Auto", "PAL", "SECAM").

Sound sys.

Select the optimum sound systems (broadcasting systems) to receive ("B/G", "D/K", "I", "L/L").

Label

When a TV channel sends its network name, the "Auto installation" detects the information and assigns a name to it. However, you can change channel names individually.

- 1 Press **▲/▼/◀/▶** to select each character of the new name for the channel, and then press **OK**.
- 2 Repeat step 1 above until the name is fully spelt out.

NOTE

- The name can be five characters or less.
- If a channel name is less than five characters, select "END" to set the channel name.

Skip

Channels with "Skip" set to "On" are passed over when using **P▲/▼** even if selected while watching the image from the TV.

Decoder

When connecting a decoder to the TV, you need to select "EXT 1" or "EXT 2".

NOTE

- The factory preset value is "Off".

Lock

You can block the viewing of any channel.

NOTE

- See "Child lock" for setting a PIN.
- When "Lock" is set to "On" for a channel, "Child lock has been activated" displays, and the image and sound of the channel are blocked.
- When pressing **⏻** while "Child lock has been activated" displays, the PIN input window will display. Inputting the correct PIN unlocks the "Child lock" temporarily until the power is turned off.

Sort

Channel positions can be sorted freely.

- 1 Press **◀/▶** to select "Yes", and then press **OK**.
- 2 Press **▲/▼/◀/▶** to select the channel you want to move, and then press **OK**.
- 3 Press **▲/▼/◀/▶** to move it to the desired position, and then press **OK**.
- 4 Repeat steps 2 and 3 until all desired channels are sorted.

Erase programme

Channels can be erased individually.

- 1 Press **◀/▶** to select "Yes", and then press **OK**.
- 2 Press **▲/▼/◀/▶** to select the channel you want to erase, and then press **OK**.
 - A message window pops up.
- 3 Press **◀/▶** to select "Yes", and then press **OK** to erase the selected channel. All the subsequent channels move up.
- 4 Repeat steps 2 and 3 until all desired channels are erased.

Basic adjustment

Password/Parental lock settings



Setup

Child lock

Allows you to use a PIN to protect certain settings from being accidentally changed.

NOTE

- PIN input is required when executing "Child lock". The default PIN is "1234". To clear the PIN setting (PIN input will no longer be needed), refer to **CLEARING THE PIN** (Page 41).

Change PIN

Register a four-digit password number to use the "Child lock" function.

- 1 Enter the four-digit number as a PIN using **0–9** numeric buttons.
- 2 Enter the same four-digit number as in step 1 to confirm.
 - "The system PIN has been changed successfully" displays.

NOTE

- To view a locked channel, you must enter the PIN (see pages 28 and 29 for locking channels from viewing in DTV and ATV mode). When you select a locked channel, a PIN prompt message pops up. Press **↵** to display the PIN input window.

Cancel PIN

Allows you to reset your PIN.

NOTE

- **As a precautionary measure, make a note of your PIN on the back of this operation manual, cut it out and keep it in a safe place that children cannot reach.**

Parental rating

This function allows DTV services to be restricted. It prevents children from watching violent or sexual scenes that may be harmful.

NOTE

- "Universal viewing" and "Parental approval pref." are ratings used exclusively in France.
- Refer to page 47 for details about ratings.

Other basic adjustments



Option

Key lock

This function allows you to lock the buttons on the TV or remote control unit in order to prohibit children from changing the channel or volume.

	Item
Off	Unlocks the buttons.
RC control lock	Locks all buttons on the remote control unit.
Button control lock	Locks the buttons on the TV except the power switch.

NOTE

You cannot set both "RC control lock" and "Button control lock" at the same time.

● Cancelling the lock

Press **MENU** on the TV and set to "Off" to cancel the "RC control lock". Press **MENU** on the remote control unit and set to "Off" to cancel the "Button control lock".

- Refer to page 22 for menu operation using **MENU** on the TV.



Setup

Quick start

You can reduce the TV's start-up time after turning on the power with the remote control unit.

	Item
On	The TV quickly starts up from standby. 30 W or more of power consumption is required during standby.
Off	Power consumption is small during standby.



Setup

Blue illumination

The LED on the front of the TV is blue when illuminated.

NOTE

- The factory default for this item is "On". Set to "Off" if you do not want the LED to illuminate.

Useful viewing functions

Selecting the picture size

Selecting the WSS picture size automatically



Setup WSS

The "WSS" allows the TV to switch automatically among the different picture size.

NOTE

- Use "WIDE MODE" if an image does not switch to the appropriate picture size. When the broadcast signal contains no "WSS" information, the function will not work even if enabled.

Selecting the WSS picture size manually



Setup 4:3 mode

The "WSS" signal has 4:3 auto-switching that allows you to select between "Normal" and "Panorama".

Item	
Normal	Normal range keeping 4:3 or 16:9 aspect ratio.
Panorama	Wide image without side bars.

WSS signal 4:3 screen

4:3 mode "Normal"



4:3 mode "Panorama"



Selecting the picture size manually

You can select the picture size. Selectable picture size varies with the type of signal received.

Item (for SD [Standard-Definition] signals)	
Normal	Keeps the original aspect ratio in a full screen display.
Zoom 14:9	For 14:9 letterbox pictures. A thin side bar appears on each side, and you may also see bars on the top and bottom with some programmes.
Panorama	In this mode, the picture is stretched toward each side of the screen. The picture may appear similar to "Full" depending on broadcast signals.
Full	For 16:9 squeeze pictures.
Cinema 16:9	For 16:9 letterbox pictures. Bars may appear on the top and bottom with some programmes.
Cinema 14:9	For 14:9 letterbox pictures. Bars may appear on the top and bottom with some programmes.

Item (for HD [High-Definition] signals)	
Full	Displays with an overscan image. Crops all sides of screen.
Underscan	Displays with an underscan image only when receiving a 720p signal. Displays with the High-Definition image adjusted optimally. Noise may appear on the edge of the screen with some programmes.
Dot by Dot	Displays an image with the same number of pixels on the screen when receiving 1080i/1080p signals only.

NOTE

- Some items do not appear depending on the type of received signal.

- Press **[WSS]**.
 - The "WIDE MODE" menu displays.
 - The menu lists the "WIDE MODE" options selectable for the type of video signal currently received.
- Press **[Left]** or **[Up/Down]** while the "WIDE MODE" menu displays on the screen.
 - As you toggle the options, each is immediately reflected on the screen. There is no need to press **OK**.

Basically, if you set "WSS" to "On" in the "Setup" menu, the optimum "WIDE MODE" is automatically chosen for every broadcast or programme played using a VCR or DVD player/recorder.

NOTE

- Even if you select your desired "WIDE MODE" manually, the TV may automatically switch to the optimum "WIDE MODE" depending on the signal received when "WSS" is set to "On".

Useful viewing functions

Selecting the recording picture size manually



Digital setup

REC picture size

You can use this menu to set the appropriate picture size for viewing a 16:9 format TV programme on a 4:3 TV.

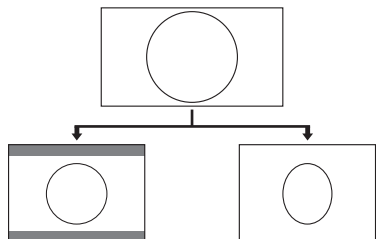

Setting to "4:3 TV"

Setting to "16:9 TV"

NOTE

- This function must be set before recording.

Selecting the HDMI picture size automatically



Setup

HDMI auto view

This function allows you to automatically change to the appropriate picture size when viewing an HDMI signal using the HDMI 1, 2, 3 and 4 terminals.

Adjusting image position



Setup

Position

For adjusting a picture's horizontal and vertical position.

	Item
H-Pos.	Centres the image by moving it to the left or right.
V-Pos.	Centres the image by moving it up or down.

NOTE

- Adjustments are stored separately for each input source.
- Depending on the input signal type or "WIDE MODE" setting, a position setting may not be available.
- This function is not available for DTV broadcasts with MHEG signals.

Language settings



Setup

Language

You can select an OSD language from the "Setup" menu. Select from among 23 languages. Refer to the **OSD language** column in the specification table for the selectable languages (Pages 44–45).



Digital setup

Subtitle

Set up to two preferred subtitle languages (including subtitles for the hearing impaired) to display if subtitles are available.

Selectable items

- 1st language
- 2nd language
- For hearing impaired

Switching subtitle languages

Each time you press on the remote control unit, the subtitle switches.

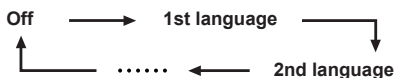

Set "For hearing impaired" to "Yes"

Subtitles for the hearing impaired have priority over each of the subtitle language settings (e.g., "1st language", "2nd language", etc.).

EXAMPLE

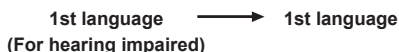

NOTE

- Subtitles will not be displayed when the programme does not contain subtitle information.



Option

Digital audio language

Set up to three preferred multi audio languages to display if the audio languages are available.

Switching the multi audio languages

Each time you press on the remote control unit, the audio language switches.

Useful viewing functions

Display settings

Channel display

You can display the channel information by pressing **(i+)** on the remote control unit.

DTV mode

BBC2 *	
DTV	001
Audio (ENG): STEREO Dolby Digital Plus Video: 1080i Subtitle: ENG 1/3 New information	

ATV mode

BBC1	
ATV	01
PAL NICAM	STEREO
Subtitle: 1/3 New information	

* Four digit numbers (e.g., 0001) are displayed after selecting the five Nordic countries in the country setting.

Time display in channel information

You can display the time information included in DTV and teletext broadcasts.

NOTE

- Skip step 1 if receiving DTV broadcasts.

- 1 Select a TV channel (the time information is automatically captured).
- 2 Press **(i+)**. The channel display will appear on the TV.
- 3 Press **(i+)** again within the several seconds that the channel display is on the screen. Time information will be shown in the lower-right corner of the screen for several seconds.
- 4 Even when you change the TV channel, you can display the time information with steps 2 and 3 above.

NOTE

- If acquired successfully, the time information will appear in the upper-right corner of the screen by pressing **MENU**.

Time and title display



Option

Time display

Time display

This function allows you to display the clock time in the lower-right corner of the screen.

Item	
On	Displays the clock time.
On (half-hourly)	Displays the clock time in 30-minute increments.
Off	Hides the clock time.

Time format

You can select the time format (either "24HR" or "AM/PM") for the clock time.



Option

Game play time

This function allows you to display the elapsed time on the screen when "AV MODE" is set to "GAME".

Item	
On	Under connecting a game console to the TV, the elapsed time is displayed in 30-minute increments after you start playing a game.
Off	Hides the time.

NOTE

- This menu is not selectable if the input source is "TV" or "USB".



Option

Programme title display

This function allows you to display programme information such as the title and airtime by tuning a channel.

NOTE

- This function is available only when the DTV mode is selected.

Other useful features

Setting when using external devices

Input source settings

Option Input select

For setting the signal type of external equipment.

Item	
EXT 1	Y/C, CVBS, RGB
EXT 2	Y/C, CVBS

NOTE

- If no (colour) image displays, try changing to another signal type.
- Check the operation manual of the external equipment for the signal type.

Setup Input label

You can label each input source with a custom description.

- 1 Press to select the desired input source.
- 2 Go to "MENU" > "Setup" > "Input label".
- 3 Press /// to select each character of the new name for the input source, and then press **OK**.

DVD											
A	B	C	D	E	F	G	H	I	J		CLEAR
K	L	M	N	O	P	Q	R	S	T		BACK
U	V	W	X	Y	Z	-	.	_			
0	1	2	3	4	5	6	7	8	9		END

- 4 Repeat until the label is fully spelt out.

NOTE

- The label can be six characters or less.
- When you want to set an input source label of less than six characters, select "END" to set the name.

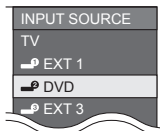

NOTE

- You cannot change labels if the input source is "TV" or "USB".

Skipping specified inputs

Setup Input skip

This setting allows you to skip the SCART, HDMI or RGB input on the input source selection operation.

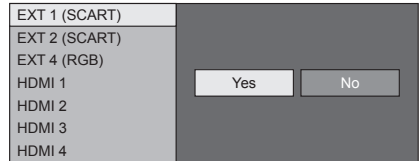

Colour system settings

Option Colour system

You can change the colour system to one that is compatible with the image on the screen.

NOTE

- The factory preset value is "Auto".
- If "Auto" is selected, the colour system for each channel is automatically set. If an image does not display clearly, select another colour system (e.g., "PAL", "SECAM").

Additional features

Option Setting display colour

You can change the background colour of the OSD (menu screen), EPG screen, channel display and programme information to blue, gray, red, or green.

Option Channel selecting effect

This function shows a screen effect when choosing or changing channels.

Other useful features

Connecting a USB device

Connect an USB device to the TV as shown below.

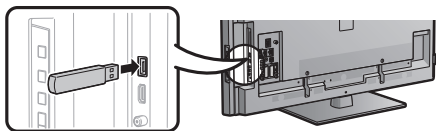

- The TV automatically switches to the USB mode when a USB device is inserted in the USB terminal.
- Depending on the USB device, the TV may not be able to recognise the contained data.
- Use only alphanumeric characters for naming files.
- File names over 80 characters (may vary depending on character set) may not be displayed.
- Do not disconnect a USB device or memory card from the TV while transferring files, using the slide show function, when a screen is switching to another or before you exit "USB" from the "INPUT SOURCE" menu.
- Do not connect and disconnect a USB device from the TV repeatedly.

USB Photo viewer/Music player

In this mode, you can enjoy viewing photos and listening to music from external USB devices. Select "USB" from the "INPUT SOURCE" menu to enter this mode.

NOTE

- You cannot enter this mode when there is no USB device connected to the TV.
- "WIDE MODE" is fixed during this mode.
- "USER (USB)" is the default value for the "AV MODE" setting. Each time you press **AV MODE**, the mode changes between "USER (USB)", "DYNAMIC (Fixed)", "DYNAMIC" and "STANDARD".

Selecting modes and devices

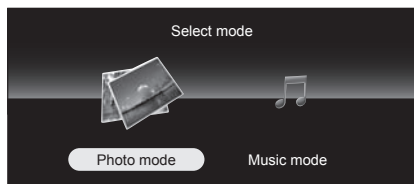

- 1 Press **◀/▶** to select between "Photo mode" and "Music mode", and then press **OK**.
- 2 Press **▲/▼/◀/▶** to select the drive where you want to find your files, and then press **OK**.

NOTE

- You do not need to select the drive in step 2 when there is only one drive in the connected USB device.
- 16 is the maximum number of drives that can be displayed.

Photo mode

Viewing thumbnails

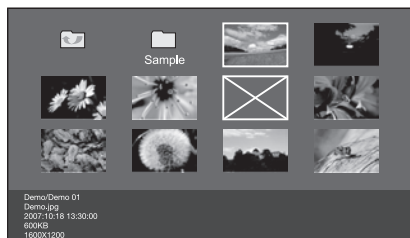

Buttons for thumbnail operations

Buttons	Description
OK	When selecting the folder icon with the ↵ mark: Go back to the parent directory. When selecting a folder icon: Enter this directory. When selecting a photo thumbnail: Display the photo in full screen.
▲/▼/◀/▶ (Cursor)	Select a desired item.
↵	Return to the top menu.
R button	Go back to the previous page.
G button	Go to the next page.
Y button	Select BGM for the slide show.
B button	Start the slide show.

NOTE

- When there are invalid photo files, the **X** mark will be displayed for the file.
- You can see the file name, shooting date, file size and pixel size of the selected photo in the lower-left corner of the screen (shooting date is only available in the EXIF file format).

Viewing photos in full screen

Buttons for full screen display operation

Buttons	Description
◀/▶ (Cursor)	Go to the previous/next photo in the same directory.
↵	Return to the thumbnail selection screen.
R button	Rotate the photo by 90 degrees to the left.
G button	Rotate the photo by 90 degrees to the right.
B button	Reveal/hide the guide display.

NOTE

- Rotating photos only applies to the temporarily selected item and this setting is not saved.

Other useful features

Slide show

Selecting the BGM

File name	Time
Demo/Demo1	
SONGS	
CLASSIC	
▶ SONG_01.MP3	3:05
▶ SONG_02.MP3	3:15
▶ SONG_03.MP3	3:02
▶ SONG_04.MP3	6:05
▶ SONG_05.MP3	4:52
✘ SONG_06.MP3	0:00
Playing:	
▶ SONG_02.MP3	1:00 / 3:15
Slide show BGM:	
SONG_03.MP3	

Buttons for slide show BGM select operation

Buttons	Description
OK	When selecting the folder icon with the ↵ mark: Go back to the parent directory. When selecting a folder icon: Enter this directory. When selecting a music file: Play music.
▲/▼ (Cursor)	Select a desired item.
◀ (Cursor)	Page up.
▶ (Cursor)	Page down.
↵	Return to the thumbnail selection screen.
R button	Stop music.
G button	Play/Pause music.
Y button	Set the selected music to the slide show BGM.
B button	Reset the slide show BGM.

NOTE

- Only one song can be set to the slide show BGM.
- Slide show BGM will be reset in the cases below.
 - Go back to the top menu.
 - Change the "INPUT SOURCE".
- When there are invalid music files, the ✘ mark will be displayed for the file.
- The displayed play time may differ slightly from the actual play time depending on the files.

Slide show

Buttons for slide show operation

Buttons	Description
↵	Return to the thumbnail selection screen.
B button	Reveal/Hide the guide display.

NOTE

- The selected BGM is played repeatedly.
- The slide show continues until you press ↵.
- The slide show speed is approximately 10 seconds per photo.

Music mode

File name	Time
Demo/Demo1	
ROOT	
CLASSIC	
▶ SONG_01.MP3	3:05
▶ SONG_02.MP3	3:15
▶ SONG_03.MP3	3:02
▶ SONG_04.MP3	6:05
▶ SONG_05.MP3	4:52
✘ SONG_06.MP3	0:00
Playing:	
▶ SONG_02.MP3	1:00 / 3:15

Buttons for music mode

Buttons	Description
OK	When selecting the folder icon with the ↵ mark: Go back to the parent directory. When selecting a folder icon: Enter this directory. When selecting a music file: Play music.
▲/▼ (Cursor)	Select a desired item.
◀ (Cursor)	Page up.
▶ (Cursor)	Page down.
↵	Return to the top menu.
R button	Stop music.
G button	Play/Pause music.
B button	Turn off the screen image for audio only output.

NOTE

- When there are invalid music files, the ✘ mark will be displayed for the file.
- The displayed play time may differ slightly from the actual play time depending on the files.

USB device compatibility

USB device	USB Memory, USB card reader (Mass Storage class)
File system	FAT/FAT32
Photo file format	JPEG (.jpg) (DCF2.0 compliant)
Music file format	MP3 (.mp3) Bitrate: 32 k, 40 k, 48 k, 56 k, 64 k, 80 k, 96 k, 112 k, 128 k, 160 k, 192 k, 224 k, 256 k, 320 kbps Sampling frequency: 32 k, 44.1 k, 48 kHz

NOTE

- Progressive format jpeg files are not supported.
- Music files in USB 1.1 devices may not be played properly.
- Operation using USB hubs is not guaranteed.

Connecting a PC

Connecting a PC

HDMI connection

PC HDMI 1, 2, 3 or 4

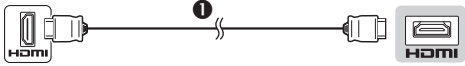

1 HDMI-certified cable

PC HDMI 2*

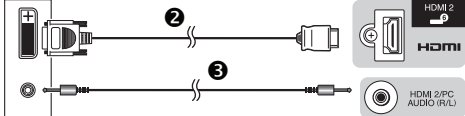

2 DVI/HDMI cable 3 ø 3.5 mm stereo minijack cable

* When using the HDMI 2 terminal, you must select the proper item in the "PC audio select" menu depending on the type of HDMI cable connected (refer to page 25 for details).

Analogue connection

PC EXT 4*

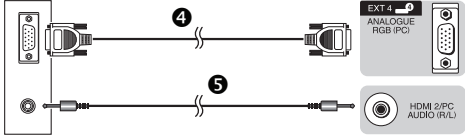

4 RGB cable 5 ø 3.5 mm stereo minijack cable

PC EXT 4*

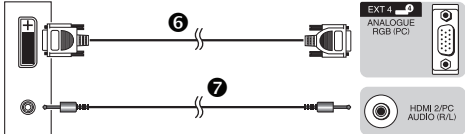

6 DVI/RGB conversion cable 7 ø 3.5 mm stereo minijack cable

* When using the EXT 4 terminal, you must select "EXT 4 (RGB)" in the "PC audio select" menu (refer to page 25 for details).

NOTE

- The PC input terminals are DDC1/2B-compatible.
- Refer to page 38 for a list of PC signals compatible with the TV.

Displaying a PC image on the screen

Selecting the picture size

You can select the picture size.

- Press **[F4]**.
 - The "WIDE MODE" menu displays.
- Press **[F4]** or **[▲/▼]** to select a desired item.

EXAMPLE

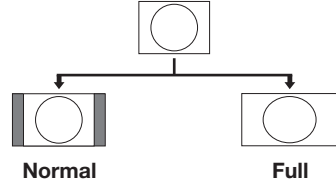

	Item
Full	An image fully fills the screen.
Cinema	For letterbox pictures. Bars may appear on the top and bottom with some programmes.
Normal	Keeps the original aspect ratio in a full screen display.
Dot by Dot	Displays an image with the same number of pixels on the screen.

NOTE

- Connect the PC before making adjustments.
- Selectable picture size may vary with input signal type.
- Refer to page 31 for AV signals.
- HDMI: 480i/480p/576i/576p/720p/1080i/1080p
- ANALOGUE RGB: 576p/720p (50 Hz)/1080i
- The ANALOGUE RGB (PC) terminal (EXT 4) is not compatible with 480i/576i/1080p signals.

Connecting a PC

Adjusting the PC image automatically

This function enables the screen to be automatically adjusted to its best possible condition when the analogue terminals of the TV and PC are connected with a commercially available DVI/RGB conversion cable, etc.



Setup

Auto sync.

NOTE

- When "Auto sync." is successful, "Auto Sync completed successfully" displays. If not, "Auto sync." failed.
- "Auto sync." may fail even if "Auto Sync completed successfully" displays.
- "Auto sync." may fail if the PC image has low resolution, has unclear (black) edges, or is moved while executing "Auto sync."
- Be sure to connect the PC to the TV and switch it on before starting "Auto sync."
- "Auto sync." can be executed only when inputting analogue signals through the EXT 4 terminal.

Adjusting the PC image manually

Ordinarily you can easily adjust the picture as necessary to change image position using "Auto sync.". In some cases, however, manual adjustment is needed to optimise the image.



Setup

Fine sync.

- 1 Press ▲/▼ to select the specific adjustment item.
- 2 Press ◀/▶ to adjust the item to the desired position.

Item	
H-Pos.	Centres the image by moving it to the left or right.
V-Pos.	Centres the image by moving it up or down.
Clock	Adjusts when the image flickers with vertical stripes.
Phase	Adjusts when characters have low contrast or when the image flickers.

NOTE

- For resetting all adjustment items to the factory preset values, press ▲/▼ to select "Reset", and then press **OK**.
- "Clock" and "Phase" in the "Fine sync." menu can be adjusted only when inputting analogue signals through the EXT 4 terminal.

PC compatibility chart

Resolution		Horizontal frequency	Vertical frequency	Analogue (D-Sub)	Digital (HDMI)	VESA standard
VGA	640 x 480	31.5 kHz	60 Hz	✓	✓	✓
SVGA	800 x 600	37.9 kHz	60 Hz	✓	✓	✓
XGA	1,024 x 768	48.4 kHz	60 Hz	✓	✓	✓
WXGA	1,360 x 768	47.7 kHz	60 Hz	✓	✓	✓
SXGA	1,280 x 1,024	64.0 kHz	60 Hz	✓	✓	✓
SXGA+	1,400 x 1,050	65.3 kHz	60 Hz		✓	✓

VGA, SVGA, XGA, WXGA, SXGA and SXGA+ are registered trademarks of International Business Machines Corporation.

NOTE

- This TV has only limited PC compatibility, correct operation can only be guaranteed if the video card conforms exactly to the VESA 60 Hz standard. Any variations from this standard will result in picture distortions.

Connecting a PC

RS-232C port specifications

PC control of the TV

- When a programme is set, the TV can be controlled from the PC using the RS-232C terminal. The input signal (PC/video) can be selected, the volume can be adjusted and various other adjustments and settings can be made, enabling automatic programmed playing.
- Use an RS-232C serial control cable (cross type) (commercially available) for the connections.

NOTE

- This operation system should be used by a person who is accustomed to using PCs.

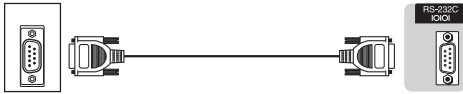

RS-232C serial control cable (cross type)

Communication conditions

Set the RS-232C communications settings on the PC to match the TV's communications conditions. The TV's communications settings are as follows:

Baud rate	9,600 bps
Data length	8 bits
Parity bit	None
Stop bit	1 bit
Flow control	None

Communication procedure

Send the control commands from the PC via the RS-232C connector.

The TV operates according to the received command and sends a response message to the PC.

Do not send multiple commands at the same time. Wait until the PC receives the OK response before sending the next command.

Make sure to send "A" with the carriage return and confirm that "ERR" returns before operating.

Command format

Eight ASCII codes +CR

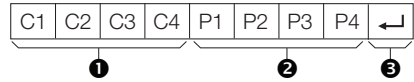

- Command four digits: Command. The text of four characters.
- Parameter four digits: Parameter 0–9, blank, ?, minus
- Return code (0DH): ←↵

Parameter

Input the parameter values, aligning left, and fill with blank(s) for the remainder (be sure that four values are input for the parameter).

When the input parameter is not within an adjustable range, "ERR" returns (refer to "Response code format").

0			
---	--	--	--

0	0	0	9
---	---	---	---

1	0	0	
---	---	---	--

0	0	5	5
---	---	---	---

When "?" is input for some commands, the present setting value responds.

?	?	?	?
---	---	---	---

Response code format

Normal response

O	K	←↵
---	---	----

Return code (0DH)

Problem response (communication error or incorrect command)

E	R	R	←↵
---	---	---	----

Return code (0DH)

Connecting a PC





RS-232C command list

CONTROL ITEM	COMMAND	PARAMETER	CONTROL CONTENTS
POWER SETTING	P O W R 0	- - -	POWER OFF (STANDBY)
INPUT SELECTION A	I T G D	- - -	INPUT SWITCHING (TOGGLE)
	I T V D	- - -	TV (CHANNEL FIXED)
	J D T V	- - -	DTV (CHANNEL FIXED)
	I A V D *	- - -	EXT 1-4, 9 (1-4, 9), HDMI 1-4 (5-8)
CHANNEL	D C C H *	* - -	TV DIRECT CHANNEL (1-99)
	C H U P	- - -	CHANNEL UP
	C H D W	- - -	CHANNEL DOWN
	D T V D *	* * -	THREE DIGIT DIRECT CHANNEL (1-999) (Non-Nordic countries)
	D T V D *	* * *	FOUR DIGIT DIRECT CHANNEL (1-9999) (Nordic countries only)
	D T U P	- - -	DTV CHANNEL UP
	D T D W	- - -	DTV CHANNEL DOWN
	INPUT SELECTION B	I N P 1 0	- - -
I N P 1 1		- - -	EXT 1 (CVBS)
I N P 1 2		- - -	EXT 1 (RGB)
I N P 2 0		- - -	EXT 2 (Y/C)
I N P 2 1		- - -	EXT 2 (CVBS)
AV MODE SELECTION	A V M D 0	- - -	TOGGLE
	A V M D 1	- - -	STANDARD
	A V M D 2	- - -	MOVIE
	A V M D 3	- - -	GAME
	A V M D 4	- - -	USER
	A V M D 5	- - -	DYNAMIC (Fixed)
	A V M D 6	- - -	DYNAMIC
	A V M D 7	- - -	PC
	A V M D 1 0 0	- - -	AUTO
	A V M D ? ? ? ?	- - -	1-?, 100
VOLUME	V O L M *	* - -	VOLUME (0-60)

CONTROL ITEM	COMMAND	PARAMETER	CONTROL CONTENTS
POSITION	H P O S *	* * -	H-POSITION (AV/PC)
	V P O S *	* * -	V-POSITION (AV/PC)
	C L C K *	* * -	CLOCK (0-180)
	P H S E *	* * -	PHASE (0-40)
WIDE MODE	W I D E 0	- - -	TOGGLE (AV)
	W I D E 1	- - -	NORMAL (AV)
	W I D E 2	- - -	ZOOM 14:9 (AV)
	W I D E 3	- - -	PANORAMA (AV)
	W I D E 4	- - -	FULL (AV)
	W I D E 5	- - -	CINEMA 16:9 (AV)
	W I D E 6	- - -	CINEMA 14:9 (AV)
	W I D E 7	- - -	NORMAL (PC)
	W I D E 8	- - -	CINEMA (PC)
	W I D E 9	- - -	FULL (PC)
	W I D E 1 0	- - -	DOT by DOT (AV/PC)
W I D E 1 1	- - -	UNDERSCAN (AV)	
MUTE	M U T E 0	- - -	TOGGLE
	M U T E 1	- - -	MUTE
	M U T E 2	- - -	MUTE OFF
SURROUND	A C S U 0	- - -	SURROUND TOGGLE
	A C S U 1	- - -	SURROUND ON
	A C S U 2	- - -	SURROUND OFF
AUDIO CHANGE	A C H A	- - -	TOGGLE
SLEEP TIMER	O F T M 0	- - -	OFF
	O F T M 1	- - -	SLEEP TIMER 30 MIN
	O F T M 2	- - -	SLEEP TIMER 1 HOUR
	O F T M 3	- - -	SLEEP TIMER 1 HOUR 30 MIN
	O F T M 4	- - -	SLEEP TIMER 2 HOUR
	O F T M 5	- - -	SLEEP TIMER 2 HOUR 30 MIN
TEXT	T E X T 0	- - -	TEXT OFF
	T E X T 1	- - -	TEXT ON (TOGGLE)
	D C P G *	* * -	DIRECT PAGE JUMP (100-899)

Appendix



Troubleshooting

Problem	Possible solution
<ul style="list-style-type: none">No power.	<ul style="list-style-type: none">Turn on (I) the MAIN POWER switch on the left side of the TV (Page 4).Check if you pressed  on the remote control unit. If the indicator on the TV lights up red, press .Is the AC cord disconnected?Check if you pressed  on the TV.
<ul style="list-style-type: none">The TV cannot be operated.	<ul style="list-style-type: none">External influences such as lightning, static electricity, etc., may cause improper operation. In this case, operate the TV after first turning off the power, or unplugging the AC cord and re-plugging it in after one or two minutes.
<ul style="list-style-type: none">Remote control unit does not operate.	<ul style="list-style-type: none">Are batteries inserted with polarity (+, -) aligned?Are batteries worn out? (Replace with new batteries.)Are you using it under strong or fluorescent lighting?Is a fluorescent light illuminating to the remote control sensor?
<ul style="list-style-type: none">Picture is cut off.	<ul style="list-style-type: none">Is the image position correct?Are screen mode adjustments (WIDE MODE) such as picture size made correctly? (Pages 31 and 37)
<ul style="list-style-type: none">Strange colour, light colour, or dark colour, or colour misalignment.	<ul style="list-style-type: none">Adjust the picture tone.Is the room too bright? The picture may look dark in a room that is too bright.Check the "Colour system" setting (Pages 29 and 34).
<ul style="list-style-type: none">Power is suddenly turned off.	<ul style="list-style-type: none">The TV's internal temperature has increased. Remove any objects blocking the vent or clean.Is the "Sleep timer" set? Select "Off" from the "Sleep timer" menu (Page 26).Is "No signal off" or "No operation off" activated? (Page 26)
<ul style="list-style-type: none">No picture.	<ul style="list-style-type: none">Are connections to external equipment correct? (Pages 16–18)Is the input signal type selected correctly after connection? (Page 34)Is the correct input source selected? (Page 12)Is a non-compatible signal being input? (Page 38)Is the picture adjustment correct? (Pages 23–24)Is the antenna connected properly? (Page 8)Is "On" selected in "Audio only"? (Page 25)
<ul style="list-style-type: none">No sound.	<ul style="list-style-type: none">Is the volume too low?Make sure that headphones are not connected.Check if you pressed  on the remote control unit.Is the proper item selected in the "PC audio select" menu when connecting devices to the HDMI 2 terminal or the EXT 4 terminal? (Pages 16 and 25)
<ul style="list-style-type: none">The TV sometimes makes a cracking sound.	<ul style="list-style-type: none">This is not a malfunction. This happens when the cabinet slightly expands and contracts according to changes in temperature. This does not affect the TV's performance.

Cautions regarding use in high and low temperature environments

- When the TV is used in a low temperature space (e.g., room, office), the picture may leave trails or appear slightly delayed. This is not a malfunction, and the TV will recover when the temperature returns to normal.
- Do not leave the TV in a hot or cold location. Also, do not leave the TV in a location exposed to direct sunlight or near a heater, as this may cause the cabinet to deform and the LCD panel to malfunction.
Storage temperature: + 5 °C to + 35 °C.

CLEARING THE PIN

- Go to "MENU" > "Setup".
- Press  /  to select "Auto installation", "Programme setup", "Child lock" or "Reset", and then press **OK**. The PIN input window will display.

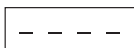

- Press and hold both   and  + on the TV simultaneously until the message appears on the screen.

Appendix

Updating your TV via DVB-T

Ensure that your TV software version is always up to date. From time to time SHARP will make updated TV base software and DVB software available.

Digital setup Download setup

Searching for updates*

* All countries except UK, Sweden and Italy are set to "No" for this function.

The TV automatically determines whether a new software version is available when the TV is in standby mode.

Item	
Yes	Automatically searches for new software updates available when the TV is in standby mode.
No	Does not search for update information.
Now	Checks if there is new software immediately.

Downloading the software

You can select the method of update.

- 1 If the software is updated, the confirmation message "New download information has been detected." appears.
 - If the TV receives the update service while in standby mode, a confirmation message displays after turning on the power.
- 2 Follow the screen prompts.

Item	
Yes	Starts downloading immediately. It takes approximately one hour to update. You cannot carry out other operations while downloading. <ul style="list-style-type: none">• Cancels the download by pressing OK on the remote control unit when "Discontinue" is displayed on the screen during the update.
No	Starts downloading automatically several minutes after entering standby mode.

NOTE

- The TV must remain in standby mode for download. Do not turn off the power using  on the TV.
- Updating the software may take some time.

Information Message list

When new software is detected, you can confirm the update information and download the software from "Message list".

NOTE

- When the TV succeeds at downloading new software, the message is updated in the "Message list" of the "Information" menu.
- The software update will not be carried out if there is no new software available at the specified download time.





Information Receiver report

Display reports regarding failures and changes for timer settings.

Reset

If complex adjustments are made so that the settings cannot be restored to normal, you can reset the settings to the factory preset values.

Setup Reset

- 1 Go to "MENU" > "Setup" > "Reset".
- 2 Press /  to select "Yes", and then press **OK**.
 - "Now, TV will restart automatically, OK?" displays on the screen.
- 3 Press /  to select "Yes", and then press **OK**.
 - "Now initialising..." displays on the screen and blinks.
 - After the reset has completed, the power shuts off and then comes back on. The screen will have returned to its original settings.

NOTE

- PIN input is required when executing "Reset". The default PIN is "1234". To change the PIN setting, refer to **Password/ Parental lock settings** (Page 30). To clear the PIN setting (PIN input will no longer be needed), refer to **CLEARING THE PIN** (Page 41).

Identification

Setup Identification

You can check the TV ID on the screen for reporting to customer service.

Appendix

Updating your TV via USB



Setup

Software update

This function allows you to update to the latest software using a USB device. You must update the software through the USB terminal.

- To check the software version for the TV, use the URL shown on the back cover.

CAUTION

- This function is available only for the 705 model series.

- 1 Go to “MENU” > “Setup” > “Software update”.
- 2 Press **OK** and then insert the USB device containing the software update file.

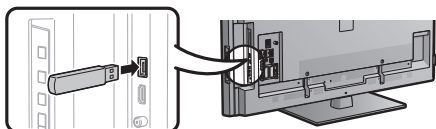

CAUTION

- Be sure to insert the USB device correctly into the terminal.

- 3 The TV displays a confirmation screen while checking the data in the inserted USB device.

CAUTION

- If the data is not compatible with the system, an error message appears on the screen. Repeat steps 2 and 3 after pressing **OK**.
 - When an error message displays, check to see if:
 - The USB device is inserted firmly.
 - The USB memory has two or more software update files.
 - No data for updating the system exists in the USB memory.
 - The software update file is broken.
 - The software update file is not compatible with your TV's software.
 - The current system is same as the system update data.
- 4 The TV displays the software version information after checking the data.
 - 5 Press **◀/▶** to select “Yes” to update the system, and then press **OK**.
 - 6 Press **OK** to automatically reset and start the update operation.
 - This operation may take a while.

The TV starts updating the system

A confirmation message appears on the screen after completing the update and then automatically restarts the TV. Press **OK** to complete the operation.

Information on the software license for this product

Software composition

The software included in this product is comprised of various software components whose individual copyrights are held by SHARP or by third parties.

Software developed by SHARP and open source software

The copyrights for the software components and various relevant documents included with this product that were developed or written by SHARP are owned by SHARP and are protected by the Copyright Act, international treaties, and other relevant laws. This product also makes use of freely distributed software and software components whose copyrights are held by third parties. These include software components covered by a GNU General Public License (hereafter GPL), a GNU Lesser General Public License (hereafter LGPL) or other license agreement.

Obtaining source code

Some of the open source software licensors require the distributor to provide the source code with the executable software components. GPL and LGPL include similar requirements. For information on obtaining the source code for the open source software and for obtaining the GPL, LGPL, and other license agreement information, visit the following website:

<http://www.sharp-eu.com/gpl/>

We are unable to answer any questions about the source code for the open source software. The source code for the software components whose copyrights are held by SHARP is not distributed.

Acknowledgements

The following open source software components are included in this product:

- linux kernel • busy box • uClibc • zlib • libpng • libjpeg • mtd-utils

Appendix

Specifications

Item			LCD COLOUR TV (32"), LC-32LE700E, LC-32LE700S, LC-32LX700E, LC-32LU700E, LC-32LU700S, LC-32LE705E, LC-32LE705S, LC-32LX705E, LC-32LU705E, LC-32LU705S	LCD COLOUR TV (40"), LC-40LE700E, LC-40LE700S, LC-40LX700E, LC-40LU700E, LC-40LU700S, LC-40LE705E, LC-40LE705S, LC-40LX705E, LC-40LU705E, LC-40LU705S
LCD panel			Advanced Super View & BLACK TFT LCD (32")	Advanced Super View & BLACK TFT LCD (40")
Resolution			2,073,600 pixels (1,920 x 1,080)	
Video colour system			PAL/SECAM/NTSC 3.58/NTSC 4.43/PAL 60	
TV function	TV-standard	Analogue	CCIR (B/G, I, D/K, L/L')	
		Digital	DVB-T (2K/8K OFDM), DVB-C	
	Receiving channel	VHF/UHF	IR A ch–E69 ch (Digital), E2–E69 ch, F2–F10 ch, I21–I69 ch, IR A–IR J ch	
		CATV	Hyper-band, S1–S41 ch	
	TV-tuning system		Auto Preset 999 ch (non-Nordic [DTV]), Auto Preset 9999 ch (Nordic [DTV]), Auto Preset 99 ch (ATV), Auto Label, Auto Sort	
STEREO/BILINGUAL		NICAM/A2		
Audio amplifier			10 W x 2	
Speaker			(35 mm x 100 mm) x 2	
Terminals	Antenna		UHF/VHF 75 Ω Din type (analogue & digital)	
	RS-232C		D-Sub 9 pin male connector	
	EXT 1		SCART (AV input, Y/C input, RGB input, TV output)	
	EXT 2		SCART (AV input/monitor output, Y/C input)	
	EXT 3		COMPONENT IN (Y/P _B (C _B)/P _R (C _R), RCA pin (AUDIO R/L))	
	EXT 4		15 pin mini D-sub	
	HDMI 1 (EXT 5)		HDMI	
	HDMI 2 (EXT 6)		HDMI	
	HDMI 3 (EXT 7)		HDMI	
	HDMI 4 (EXT 8)		HDMI	
	EXT 9		RCA pin (AV input)	
	USB		USB	
	HDMI 2/PC AUDIO (R/L)		Ø 3.5 mm jack*1	
	DIGITAL AUDIO OUTPUT		Optical S/PDIF digital audio output	
	C. I. (Common Interface)		EN50221, R206001, CI Plus specification	
OUTPUT		RCA pin (AUDIO R/L)		
Headphones		Ø 3.5 mm jack (audio output)		
OSD language			Czech, Danish, Dutch, English, Estonian, Finnish, French, German, Greek, Hungarian, Italian, Latvian, Lithuanian, Norwegian, Polish, Portuguese, Russian, Slovak, Slovene, Spanish, Swedish, Turkish, Ukrainian	
Power requirement			AC 220–240 V, 50 Hz	
Power consumption (method IEC62087)			93 W (0.2 W standby*2)	133 W (0.2 W standby*2)
Weight			10.5 kg (without stand), 13.5 kg (with stand)	12.3 kg (without stand), 16.2 kg (with stand)
Operating temperature			0 °C to + 40 °C	

*1 The HDMI 2 and EXT 4 terminals can both use the same audio input terminal.

*2 Standby power consumption applies when the TV is set to not receive EPG data.

Appendix

Item		LCD COLOUR TV (46"), LC-46LE700E, LC-46LE700S, LC-46LX700E, LC-46LU700E, LC-46LU700S, LC-46LE705E, LC-46LE705S, LC-46LX705E, LC-46LU705E, LC-46LU705S	LCD COLOUR TV (52"), LC-52LE700E, LC-52LE700S, LC-52LE705E, LC-52LE705S
LCD panel		Advanced Super View & BLACK TFT LCD (46")	Advanced Super View & BLACK TFT LCD (52")
Resolution		2,073,600 pixels (1,920 x 1,080)	
Video colour system		PAL/SECAM/NTSC 3.58/NTSC 4.43/PAL 60	
TV function	TV-standard	Analogue	CCIR (B/G, I, D/K, L/L')
		Digital	DVB-T (2K/8K OFDM), DVB-C
	Receiving channel	VHF/UHF	IR A ch–E69 ch (Digital), E2–E69 ch, F2–F10 ch, I21–I69 ch, IR A–IR J ch
		CATV	Hyper-band, S1–S41 ch
	TV-tuning system	Auto Preset 999 ch (non-Nordic [DTV]), Auto Preset 9999 ch (Nordic [DTV]), Auto Preset 99 ch (ATV), Auto Label, Auto Sort	
STEREO/BILINGUAL		NICAM/A2	
Audio amplifier		10 W x 2	
Speaker		(35 mm x 100 mm) x 2	
Terminals	Antenna	UHF/VHF 75 Ω Din type (analogue & digital)	
	RS-232C	D-Sub 9 pin male connector	
	EXT 1	SCART (AV input, Y/C input, RGB input, TV output)	
	EXT 2	SCART (AV input/monitor output, Y/C input)	
	EXT 3	COMPONENT IN (Y/P _B (C _B)/P _R (C _R), RCA pin (AUDIO R/L))	
	EXT 4	15 pin mini D-sub	
	HDMI 1 (EXT 5)	HDMI	
	HDMI 2 (EXT 6)	HDMI	
	HDMI 3 (EXT 7)	HDMI	
	HDMI 4 (EXT 8)	HDMI	
	EXT 9	RCA pin (AV input)	
	USB	USB	
	HDMI 2/PC AUDIO (R/L)	Ø 3.5 mm jack*1	
	DIGITAL AUDIO OUTPUT	Optical S/PDIF digital audio output	
	C. I. (Common Interface)	EN50221, R206001, CI Plus specification	
	OUTPUT	RCA pin (AUDIO R/L)	
Headphones	Ø 3.5 mm jack (audio output)		
OSD language		Czech, Danish, Dutch, English, Estonian, Finnish, French, German, Greek, Hungarian, Italian, Latvian, Lithuanian, Norwegian, Polish, Portuguese, Russian, Slovak, Slovene, Spanish, Swedish, Turkish, Ukrainian	
Power requirement		AC 220–240 V, 50 Hz	
Power consumption (method IEC62087)		162 W (0.2 W standby*2)	189 W (0.2 W standby*2)
Weight		18.5 kg (without stand), 23.5 kg (with stand)	22.5 kg (without stand), 27.6 kg (with stand)
Operating temperature		0 °C to + 40 °C	

*1 The HDMI 2 and EXT 4 terminals can both use the same audio input terminal.

*2 Standby power consumption applies when the TV is set to not receive EPG data.

- As a part of our policy of continuous improvement, SHARP reserves the right to make design and specification changes for product improvement without prior notice. The performance specification figures indicated are nominal values of production units. There may be some deviations from these values in individual units.

NOTE

- Refer to the inside back cover for dimensional drawings.

Appendix

Environmental specifications

Item		32 inch models	40 inch models	46 inch models	52 inch models	
*1	On-Mode (W) (HOME MODE)	60 W	72 W	89 W	98 W	
*2	Energy-Save-Mode (W)	Advanced	54 W	70 W	81 W	92 W
*3	Standby-Mode (W)		0.20 W	0.20 W	0.20 W	0.20 W
*4	Off Mode (W)	Power button	0.19 W	0.19 W	0.19 W	0.19 W
		MAIN POWER switch	0.01 W or less	0.01 W or less	0.01 W or less	0.01 W or less
*5	Annual Energy Consumption (kWh)	87.6 kWh	105.1 kWh	129.9 kWh	143.1 kWh	
*6	Annual Energy Consumption Energy-Save-Mode (kWh)	Advanced	78.8 kWh	102.2 kWh	118.3 kWh	134.3 kWh

*1 Measured according to IEC 62087 Ed. 2

*2 For further information about the Energy Save function, please see related pages in this operation manual

*3 Measured according to IEC 62301 Ed. 1

*4 Measured according to IEC 62301 Ed. 1

*5 Annual energy consumption is calculated on the basis of the On-Mode (HOME MODE) power consumption, watching TV 4 hours a day, 365 days a year

*6 Annual energy consumption is calculated on the basis of the Energy-Save-Mode power consumption, watching TV 4 hours a day, 365 days a year

NOTE

- The power consumption of On-Mode varies depending on the images the TV displays.

Optional accessories

The listed optional accessories are available for this LCD colour TV. Please purchase them at your nearest shop.

- Additional optional accessories may be available in the near future. When purchasing, please read the newest catalogue for compatibility and check the availability.

No.	Part name	Part number	Notes
1	Wall mount bracket (32 inch models)	AN-37AG5	The centre of the TV screen is 5 mm below the mark "B" on the wall bracket.
2	Wall mount bracket (40 inch models)	AN-37AG2	The centre of the TV screen is 20 mm below the mark "B" on the wall bracket.
3	Attachment (40 inch models)	AN-37P30	
4	Wall mount bracket (46 inch models)	AN-52AG4	The centre of the TV screen is 1.3 mm below the mark "b" on the wall bracket.
5	Wall mount bracket (52 inch models)	AN-52AG4	The centre of the TV screen is 1.75 mm below the mark "b" on the wall bracket.

Appendix

Rating table for child lock

User-adjusted rating	Broadcasted rating														
	AGE														
	4	5	6	7	8	9	10	11	12	13	14	15	16	17	18
Universal viewing	✓	–	–	–	–	–	–	–	–	–	–	–	–	–	–
Parental approval pref.	✓	✓	✓	✓	✓	–	–	–	–	–	–	–	–	–	–
X-rated	✓	✓	✓	✓	✓	✓	✓	✓	✓	✓	✓	✓	✓	✓	✓

User-adjusted rating	Broadcasted rating		
	Universal viewing	Parental approval pref.	X-rated
Universal viewing	–	–	–
Parental approval pref.	✓	–	–
X-rated	✓	✓	–

Abbreviation list

Abbreviated term	Stands for
ATV	Analogue TV
CEC	Consumer Electronics Control
DNR	Digital Noise Reduction
DTV	Digital TV
DVB-C	Digital Video Broadcasting-Cable
DVB-T	Digital Video Broadcasting-Terrestrial
DVI	Digital Visual Interface
EPG	Electronic Programme Guide
HDCP	High-bandwidth Digital Content Protection
HDMI	High-Definition Multimedia Interface
MHEG	Multimedia and Hypermedia Expert Group
OSD	On Screen Display
PCM	Pulse Code Modulation
USB	Universal Serial Bus
WSS	Wide Screen Signalling
WYSIWYR	What You See Is What You Record

End of life disposal



Attention: Your product is marked with this symbol. It means that used electrical and electronic products should not be mixed with general household waste. There is a separate collection system for these products.

A. Information on Disposal for Users (private households)

1. In the European Union

Attention: If you want to dispose of this equipment, please do not use the ordinary dust bin!

Used electrical and electronic equipment must be treated separately and in accordance with legislation that requires proper treatment, recovery and recycling of used electrical and electronic equipment. Following the implementation by member states, private households within the EU states may return their used electrical and electronic equipment to designated collection facilities free of charge*. In some countries* your local retailer may also take back your old product free of charge if you purchase a similar new one. *) Please contact your local authority for further details.

If your used electrical or electronic equipment has batteries or accumulators, please dispose of these separately beforehand according to local requirements.

By disposing of this product correctly you will help ensure that the waste undergoes the necessary treatment, recovery and recycling and thus prevent potential negative effects on the environment and human health which could otherwise arise due to inappropriate waste handling.

2. In other Countries outside the EU

If you wish to discard this product, please contact your local authorities and ask for the correct method of disposal.

For Switzerland: Used electrical or electronic equipment can be returned free of charge to the dealer, even if you don't purchase a new product. Further collection facilities are listed on the homepage of www.swico.ch or www.sens.ch.

B. Information on Disposal for Business Users

1. In the European Union

If the product is used for business purposes and you want to discard it:

Please contact your SHARP dealer who will inform you about the take-back of the product. You might be charged for the costs arising from take-back and recycling. Small products (and small amounts) might be taken back by your local collection facilities.

For Spain: Please contact the established collection system or your local authority for take-back of your used products.

2. In other Countries outside the EU

If you wish to discard of this product, please contact your local authorities and ask for the correct method of disposal.



Pb

The battery supplied with this product contains traces of Lead.

For EU: The crossed-out wheeled bin implies that used batteries should not be put to the general household waste! There is a separate collection system for used batteries, to allow proper treatment and recycling in accordance with legislation. Please contact your local authority for details on the collection and recycling schemes.

For Switzerland: The used battery is to be returned to the selling point.

For other non-EU countries: Please contact your local authority for correct method of disposal of the used battery.

52"/46"

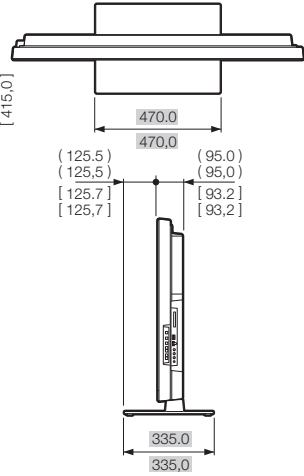
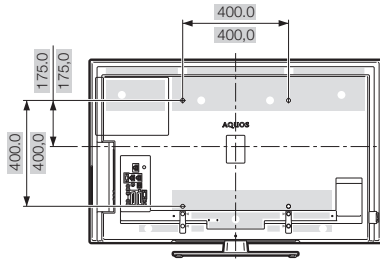
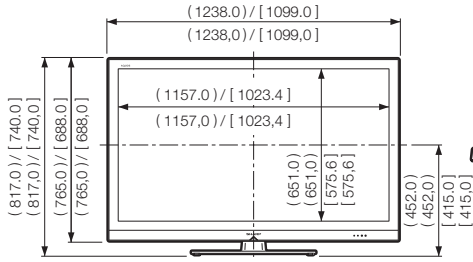

() 52"
 [] 46"
 ■ 52"/46"

40"/32"

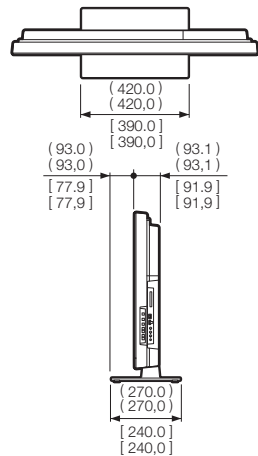
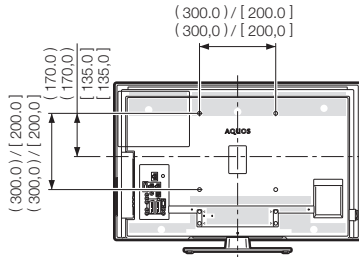
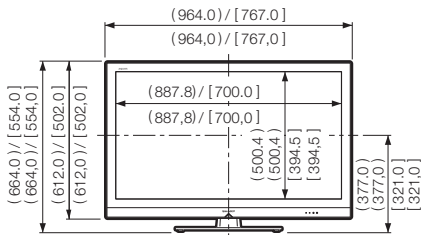

() 40"
 [] 32"

SHARP®

SHARP ELECTRONICS (Europe) GmbH

Sonninstraße 3, D-20097 Hamburg

SHARP CORPORATION

<http://www.sharp-eu.com>

Printed in Poland
Gedruckt in Polen
Imprimé en Pologne
Stampato in Polonia
Gedruckt in Polen
Impreso en Polonia
Impresso na Polónia

TINS-E281WJN1
09P10-PL-NG

PIN

--	--	--	--